



WEO PLUG-IN

# CEJN WEO Plug-In

*Hydraulic fitting technology – made easy and cost-effective*



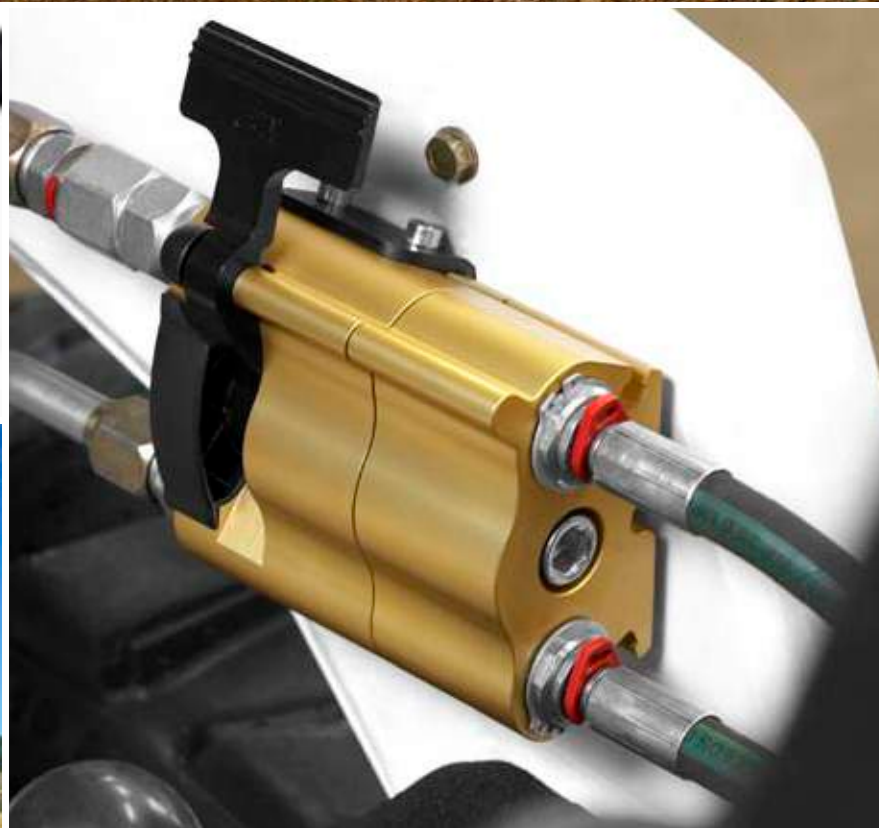

*WEO Plug-In Hose Fittings - Save installation time and money by simply "plugging in" to hydraulic systems*

## Content

<b>04</b>	<b>CEJN QUICK COUPLING PRODUCTS</b> <i>- Quickly Chosen by Customers Around the World</i>
<b>06</b>	<b>BENEFITS ADD UP TO ECONOMICAL CONNECTIONS</b>
<b>08</b>	<b>CONNECTION/DISCONNECTION</b>
<b>09</b>	<b>TECHNICAL DATA</b>
<b>10</b>	<b>REFERENCES</b>
<b>13</b>	<b>PRODUCT RANGE</b>



CEJN Corporate Headquarter  
CEJN AB  
Skövde, Sweden



ISO 9001 certified since 1995.  
ISO 14001 certified since 2006.

## CEJN WEO Plug-In

– *Quickly Chosen by Customers Around the World*

*When customers all over the world need fluid systems to function without failure, they turn to CEJN for innovative, problem-solving products. CEJN's reputation as a leader in fluid system components began over five decades ago when the company pioneered compressed air couplings at a fledgling assembly plant in Skövde, Sweden.*

Today, that venerable facility stands as the international headquarters for CEJN, which now encompasses sales operations on four continents in 21 countries. The CEJN product line has evolved into a wide range of quick coupling styles that are quickly chosen for applications involving not only the transfer of compressed air, but also hydraulic oils, fluids, gases, and more. Also included in the CEJN product line are accessory products, such as adapters, fittings, hose, hose reels, air-preparation units, and blowguns.

### PRODUCT MODIFICATIONS, ALL-NEW DESIGNS

The company's hard-working commitment to developing new products also includes:

- Modifying existing products when higher performance standards are required – and "off-the-shelf" components won't do. By continually investing in new processes and technologies, CEJN has the capability to modify products that exceed their original performance parameters and customer expectations.
- Designing and manufacturing limited quantities of custom couplings that are needed by customers to replace troublesome products or build into new or existing applications. CEJN provides complete product solutions from design to installation-ready components that are qualified, tested, and backed by after-sale support.

Whether it's a special coupling requirement for material, temperature range, end connection, or flow rate, CEJN engineers analyze each requirement and determine whether to build it into an existing product or an all-new design.

### PIONEERING SPIRIT LEADS TO WEO PLUG-IN HOSE FITTINGS

In fact, this pioneering spirit has led to CEJN's entry into threadless connector market with the development of WEO Plug-In hose fittings – CEJN's response to customer inquiries for end connections that simply "plug in" to hydraulic systems. The innovative click-to-connect feature of WEO fittings eliminates the need for tools or wrenches that are needed to connect and disconnect traditional threaded fittings.

WEO fittings are leak-free and slash downtime for assembly and field maintenance, since only a common screwdriver is needed to remove hose assemblies.

As more and more applications industry-wide are being converted from threaded to threadless connectors, WEO Plug-In hose fittings are becoming the connection of choice by well-known original equipment manufacturers for critical equipment applications.

Backed by extensive laboratory and field-testing, WEO fittings, offered with numerous connection options, are being used by leading companies that supply products all over the world.

### PARTNERING WITH HOSE MANUFACTURERS

In fact, because of the industry's acceptance of CEJN threadless fittings, several international hose manufacturers have partnered with CEJN in offering their customers hose assemblies equipped with CEJN WEO products. These assemblies are of high interest to customers that are looking for a reliable, proven threadless design that is backed by a premier hose manufacturer.

As a result, more and more global customers are "plugging in" to hydraulic systems without tools or wrenches by specifying problem-solving WEO Plug-In hose fittings from CEJN, your quick connect specialist.



### WEO Plug-In Hose Fittings

- + Downtime, installation time dramatically reduced
- + Easy to connect and disconnect
- + Leak-free connections
- + No follow-up tightening needed
- + Minimum space requirement enables new system designs
- + Work injuries associated with connection/disconnection are eliminated
- + Longer hose life
- + Easy to service

---

**= Lower Overall Cost**

## Benefits Add Up to Economical Connections

### DOWNTIME, INSTALLATION TIME DRAMATICALLY REDUCED

CEJN WEO Plug-In hose fittings slash downtime and installation time for original equipment manufacturers. The click-to-connect and self-aligning features of the fittings make them easy to install in hydraulic systems, which will lead to dramatically cost reduce.

### EASY TO CONNECT AND DISCONNECT

WEO fittings are designed with an innovative click-to-connect feature that provides easy engagement of the product's male and female halves, without the aid of tools or wrenches.

### LEAK-FREE CONNECTIONS

Since WEO fittings "plug in" tightly to hydraulic systems, hydraulic leakage is virtually eliminated.

### NO FOLLOW-UP TIGHTENING NEEDED

WEO fittings automatically lock into place, eliminating the need for tightening during follow-up checks.

### MINIMUM SPACE REQUIREMENT ENABLES NEW SYSTEM DESIGNS

WEO fittings make it easier to build compact, reliable hydraulic systems that include hose and tubes, since access for hand-tool clearance is not a requirement.

### WORK INJURIES ASSOCIATED WITH CONNECTION/DISCONNECTION ARE ELIMINATED

Since WEO fittings are quick and easy to connect and disconnect, physical injuries associated with tightening and untightening traditional threaded connections no longer occur.

### LONGER HOSE LIFE

WEO fittings are self-aligning, which eliminates twisted hose that can occur during connection, and thereby extend hose life.

### EASY TO SERVICE

The simple connection and disconnection of WEO fittings make it easy to replace hose assemblies with only a common screwdriver, even in confined or difficult-to-reach applications.

### LOWER OVERALL COST

The click-to-connect feature of WEO threadless fittings greatly reduces installation time for equipment manufacturers. The fittings' ability to eliminate leakage and improve accessibility also add to their lower overall cost than threaded-type fittings.



# Connection

1. Make sure the assembly stop is in place and the release ring runs freely in its groove.

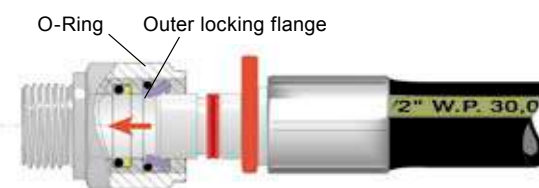
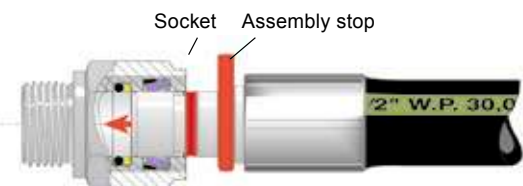
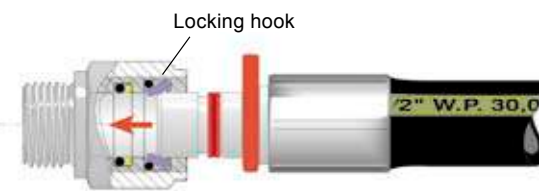
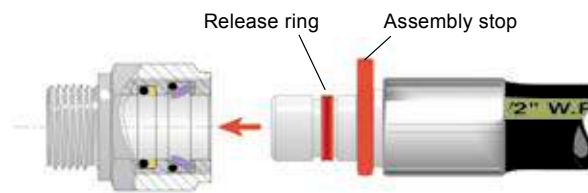

2. Push the plug all the way in until the assembly stop touches the socket.

3. The O-ring presses the locking hooks inwards so that they grip the outer locking flange on the plug. The coupling is now locked and cannot be disconnected.

# Disconnection

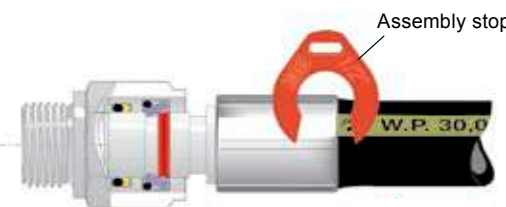

1. Using a screwdriver, remove the assembly stop.

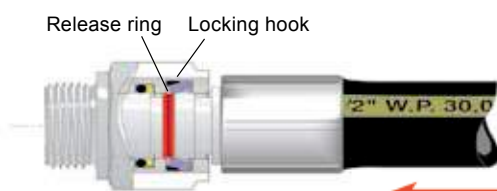

2. Push the plug all the way in so that the release ring pushes the locking hooks aside.

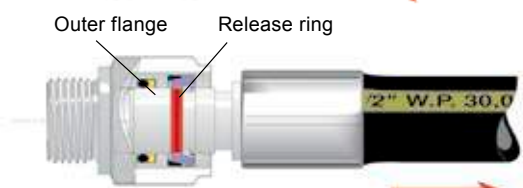

3. Pull the plug out.

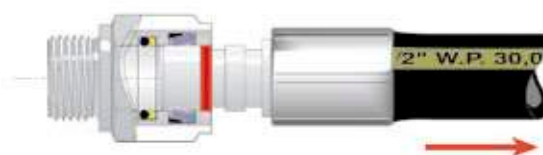

# Technical Data

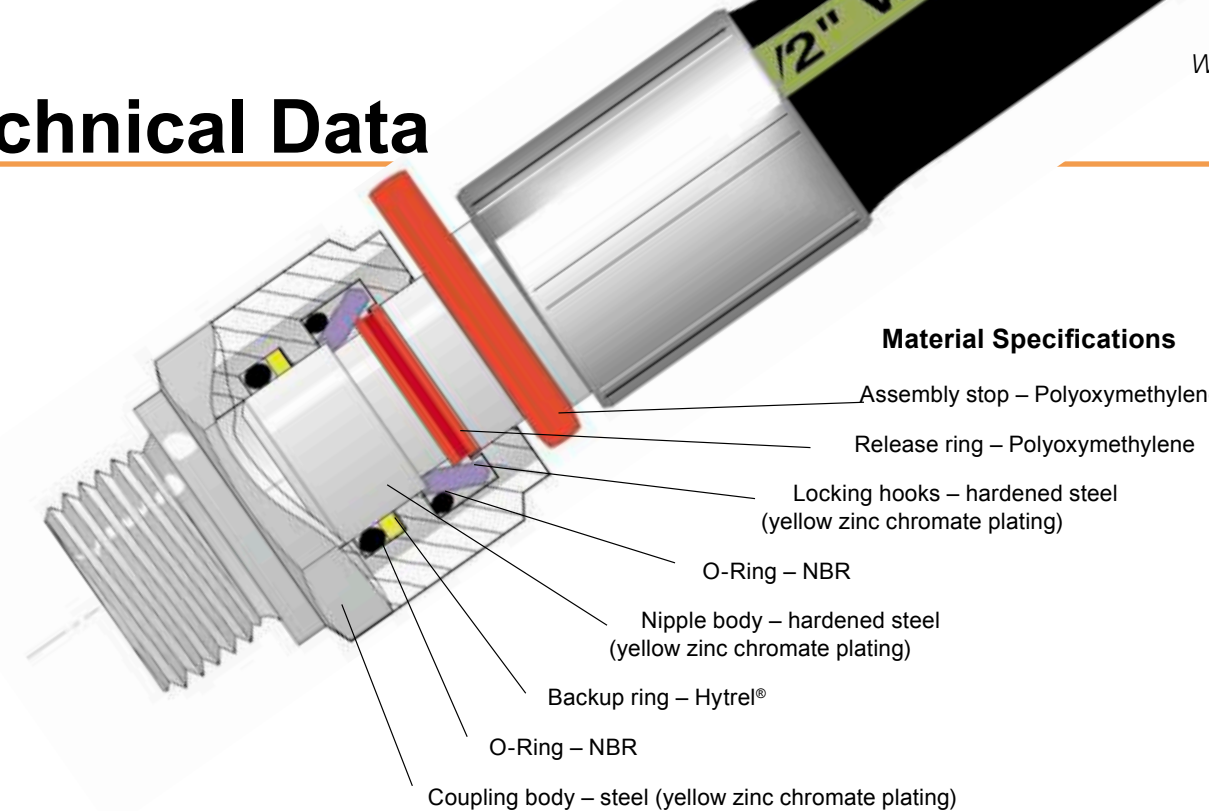

### Material Specifications

Assembly stop – Polyoxymethylene

Release ring – Polyoxymethylene

Locking hooks – hardened steel (yellow zinc chromate plating)

O-Ring – NBR

Nipple body – hardened steel (yellow zinc chromate plating)

Backup ring – Hytrel®

O-Ring – NBR

Coupling body – steel (yellow zinc chromate plating)

### Tests

WEO Plug-In hose fittings have been tested and approved by the Swedish Institute of Materials Testing and Research to SS-ISO 8032 – Half Omega Test, and have been burst tested to a minimum pressure of four times the working pressure. The fittings have also been tested and approved by TÜV, Germany.

### Working Pressure, Safety Factor

WEO fitting sizes 1/4 inch through 3/4 inch have a maximum working pressure of 5075 PSI (350 bar). The 1-inch size has a maximum working pressure of 3625 PSI (250 bar). A minimum safety factor of 4:1 between burst pressure and working pressure applies to all sizes.

Note: Working pressure may vary among sizes. Refer to the data for each product range.

### Temperature Range

-22°F – +212°F (-30°C – +100°C)

### Hose Size Working Pressure

-03	3/16"	5076 PSI
-04	1/4"	5076 PSI
-05	5/16"	5076 PSI
-06	3/8"	5076 PSI
-08	1/2"	5076 PSI
-10	5/8"	5076 PSI
-12	3/4"	5076 PSI
-16	1"	3626 PSI

### Hose Standards

SAE	DIN	EN
100R1A	1ST 20022	853-1ST
100R1AT	1SN 20022	853-1SN
100R2A	2ST 20022	853-2ST
100R2AT	2SN 20022	853-2SN
100R9R	4SP 20023	856-4SP
		857-1SC
		857-2SC

### Compatible Hose Styles

WEO Plug-In hose stems can be crimped onto most common styles of single- and multiple-braid hydraulic hose up through 1 inch (-16 size) and light spiral reinforced hose. Use the standard tooling and corresponding collar (sleeve, ferrule, socket, etc.) for each type of hose. Crimping instructions see Instructions at [www.weoplugin.com](http://www.weoplugin.com).



## WEO Products Are a Natural Fit at Kanglim

“Here at Kanglim, we place a major emphasis on using only state-of-the-art hydraulic technology in our production of truck-mounted cranes and special-purpose vehicles. This kind of commitment to innovation makes WEO Plug-In hose fittings a natural fit at our assembly facility in Chungcheongbuk-do, Korea.

“WEO fittings are used on high-pressure oil lines on the rotating arms of Kanglim auger cranes. The self-alignment of WEO fittings allows the connecting hose to move freely during installation, which has eliminated the problems of twisted hose and resultant shortened hose life.

“The use of threadless WEO fittings also has enabled us to reduce assembly time for the auger cranes, since the fittings require only a quick ‘click’ to connect and disconnect them.

“Because of the important, problem-solving benefits of WEO products, I would not hesitate to recommend them to other companies with similar applications.”

**CONTACT PERSON:**  
Chan Ho Kim  
Deputy General Manager  
Crane Technical Design –  
Research & Development Center

**COMPANY:**  
Kanglim Company, Ltd.  
Chungcheongbuk-do, Korea  
www.kanglim.com

## Brokk Makes Buildings Come Tumbling Down with Aid of WEO Products



“Getting in and out of job sites on time in order not to disrupt critical time schedules and budgets is very important to us. Therefore, it is crucial that Brokk remote-controlled demolition robots are equipped with components that are quick and easy to repair.

“For this reason, Brokk AB has supplied WEO Plug-In hose fittings on hydraulic oil lines on a robot being used for sorting and demolition in a nuclear waste station.

“The product has appealed to us because it is so quick and easy to install and makes replacing hose assemblies almost effortless.

“At job sites, such as nuclear waste stations in which it can be extremely tough to make hose assembly replacements due to the dangerous working environment, WEO products may be just the solution we need.”

## Rottne Logging Equipment Clears the Way for WEO Fittings

“Rottne logging cranes have very compact designs, which do not offer a lot of clearance area for installing and repairing hose assemblies with traditional threaded fittings and working with the required hand tools.

“CEJN’s WEO Plug-In fittings are a handy product for us because they are quick and easy to connect and disconnect without wrenches.

“Here at our assembly facility in Rottne, Sweden, we use them on hydraulic lines on the cranes’ extension cylinders.

“In the past, we have found that with screw-in fittings, it is impossible to replace these hydraulic lines without completely dismantling the cylinders.

“With WEO fittings, downtime for field maintenance is minimal, since only a screwdriver is needed to remove the assemblies, and replacements just click into place.

“We have been using WEO products for the past five years and have had no problems with their installation or performance.”



**CONTACT PERSON:**  
Göran Johansson  
Design Engineer

**COMPANY:**  
Rottne Industri AB, Rottne, Sweden  
www.rottnes.com



## WEO Products Are Earth Moving at Komatsu

“For the past two years, we have been using WEO connectors to join hose assemblies to servo controls on our Komatsu earth moving equipment. These threadless connectors appealed to us because of the difficulty we experienced in installing threaded connectors in confined areas.

“WEO connectors are easy to install and also provide easy maintenance and reliable sealing. Since we build hundreds of machines each month that require literally thousands of hose assemblies, these are important benefits to us.

“We purchase the WEO-equipped hose assemblies from a hose manufacturer that, along with CEJN, provides valuable technical assistance. WEO’s reliable performance and its support from two companies give us confidence in the product.”

**CONTACT PERSON:**  
Gianni Contato, Supplier Auditor – Quality Assurance Department

**COMPANY:**  
Komatsu Utility Europe, Este, Italy  
www.komatsu.it

## WEO Products Give Palfinger Cranes a Lift

“The fact that threadless connectors do not require a lot of space for installation is what led us to try them on our loading cranes.

“The hydraulic control valves on Palfinger cranes have numerous hose connections, but are located in an area with virtually no space for hand tools that are required for making threaded connections.

“With our knowledge of threadless connectors, we decided to try CEJN WEO Plug-In hose fittings on the valve banks. After determining what fitting heat treatment processes would and wouldn’t work for us, we are pleased with WEO’s performance.

“Installing hose assemblies is no longer a problem at our assembly facility here in Salzburg, Austria, or on the job site when hose replacements are needed.

“I would highly recommend WEO products to other manufacturers that have limited access space on their equipment. WEO fittings that automatically lock into place have been the answer for us.”



**CONTACT PERSON:**  
Reinhard Sunkler, Purchasing – Hydraulic Parts Procurement

**COMPANY:**  
Palfinger AG, Salzburg, Austria  
www.palfinger.com

## Nipples – Straight Hose Connection

Series 710 features Plug-In nipples with straight hose connections for one/two wire braided hydraulic hose in sizes 1/4" to 1"

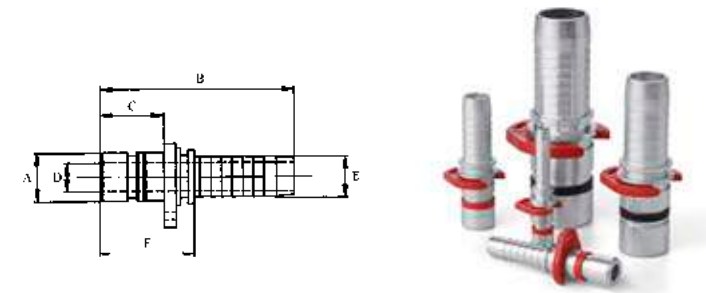

**TECHNICAL DATA**  
Material nipple..... Hardened Steel  
Temperature range ..... -22°F – +212°F (-30°C – +100°C)

	Part No.	Connection	Max working pressure	A	B	C	D	F
<b>NIPPLE, 1/4"</b>	147100403	3/16" (5.25 mm)	5080 PSI (350 bar)	10.0	54.5	19.0	2.8	29.2
	147100404	1/4" (6.9 mm)	5080 PSI (350 bar)	10.0	58.0	19.0	4.5	30.0
<b>NIPPLE, 3/8"</b>	147100604	1/4" (6.9 mm)	5080 PSI (350 bar)	13.0	61.0	22.0	4.5	33.0
	147100605	5/16" (8.6 mm)	5080 PSI (350 bar)	13.0	61.0	22.0	5.6	33.0
	147100606	3/8" (10.1 mm)	5080 PSI (350 bar)	13.0	63.0	22.0	7.0	33.0
<b>NIPPLE, 1/2"</b>	147100806	3/8" (10.1 mm)	5080 PSI (350 bar)	16.0	63.0	22.0	7.0	33.0
	147100808	1/2" (13.6 mm)	5080 PSI (350 bar)	16.0	64.0	22.0	9.5	33.0
<b>NIPPLE, 3/4"</b>	147101208	1/2" (13.6 mm)	5080 PSI (350 bar)	23.0	73.5	31.0	9.5	42.5
	147101210	5/8" (16.8 mm)	5080 PSI (350 bar)	23.0	77.5	31.0	12.0	43.3
	147101212	3/4" (20 mm)	5080 PSI (350 bar)	23.0	82.0	31.0	15.0	43.0
<b>NIPPLE, 1"</b>	147101616	1" (26.2 mm)	3630 PSI (250 bar)	30.0	100.5	38.5	21.0	54.0

All measurements are in mm. Check with an authorized CEJN distributor for availability and prices. Please visit our website, www.cejn.com, for general maintenance tips.

## Nipples – 45° Hose Connection

Series 712 features Plug-In nipples with 45° hose connections for one/two wire braided hydraulic hose in sizes 1/4" to 3/4"

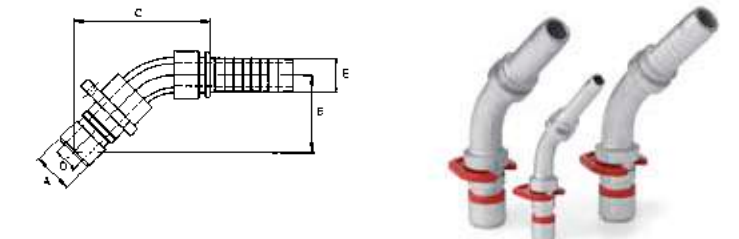

**TECHNICAL DATA**  
Material nipple..... Hardened steel  
Temperature range ..... -22°F – +212°F (-30°C – +100°C)

	Part No.	Connection	Max working pressure	A	B	C	D
<b>NIPPLE, 1/4"</b>	147120404	1/4" (6.9 mm)	5080 PSI (350 bar)	10.0	28.0	51.0	4.5
<b>NIPPLE, 3/8"</b>	147120606	3/8" (10.1 mm)	5080 PSI (350 bar)	13.0	33.0	59.0	7.0
<b>NIPPLE, 1/2"</b>	147120808	1/2" (13.6 mm)	5080 PSI (350 bar)	16.0	36.0	66.0	9.0
<b>NIPPLE, 3/4"</b>	147121208	1/2" (13.6 mm)	5080 PSI (350 bar)	23.0	44.0	73.0	9.0
	147121210	5/8" (16.8 mm)	5080 PSI (350 bar)	23.0	55.0	103.0	13.0
	147121212	3/4" (20,0 mm)	5080 PSI (350 bar)	23.0	55.0	103.0	15.0

All measurements are in mm. Check with an authorized CEJN distributor for availability and prices. Please visit our website, www.cejn.com, for general maintenance tips.

## Nipples – 90° Hose Connection

Series 714 features Plug-In nipples with 90° hose connections for one/two wire braided hydraulic hose in sizes 1/4" to 3/4"

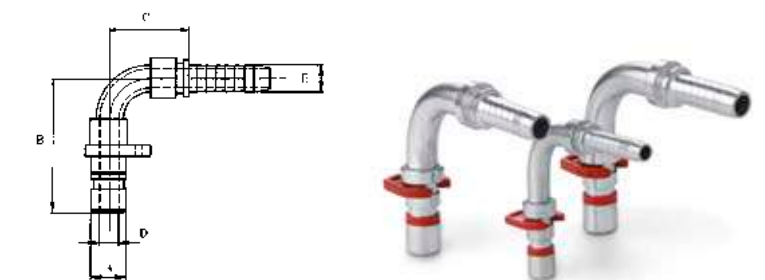

**TECHNICAL DATA**  
Material nipple..... Hardened steel  
Temperature range ..... -22°F – +212°F (-30°C – +100°C)

	Part No.	Connection	Max working pressure	A	B	C	D
<b>NIPPLE, 1/4"</b>	147140404	1/4" (6.9 mm)	5080 PSI (350 bar)	10.0	51.0	34.0	4.5
<b>NIPPLE, 3/8"</b>	147140606	3/8" (10.1 mm)	5080 PSI (350 bar)	13.0	60.0	39.0	7.0
<b>NIPPLE, 1/2"</b>	147140806	3/8" (10.1 mm)	5080 PSI (350 bar)	16.0	61.0	39.0	7.0
	147140808	1/2" (13.6 mm)	5080 PSI (350 bar)	16.0	69.0	48.0	9.0

All measurements are in mm. Check with an authorized CEJN distributor for availability and prices. Please visit our website, www.cejn.com, for general maintenance tips.

# Nipples – Straight Hose Connection

Series 716 features Plug-In nipples with straight hose connections for one/two wire braided hydraulic hose in sizes 3/8" to 1". This nipple series is specifically made to correspond to the WEO Plug-In swivel Series 860.

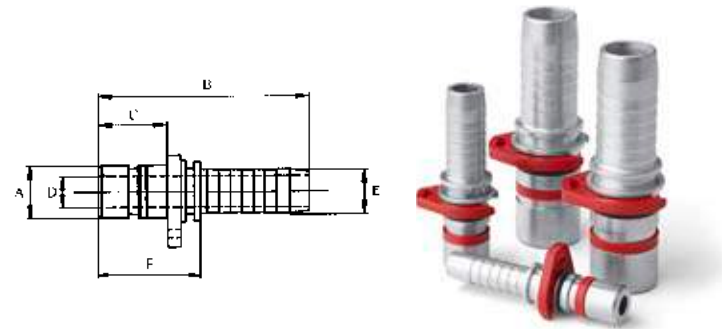

**TECHNICAL DATA**  
 Material nipple..... Hardened steel  
 Temperature range ..... -22°F – +212°F (-30°C – +100°C)

Part No.	Connection	Max working pressure	A	B	C	D	F	
<b>NIPPLE, 3/8"</b>	147160616	3/8" (10.1 mm)	5080 PSI (350 bar)	13.0	63.0	22.3	6.5	33.0
<b>NIPPLE, 1/2"</b>	147160818	1/2" (13.6 mm)	5080 PSI (350 bar)	16.0	64.0	22.5	9.0	33.0
<b>NIPPLE, 3/4"</b>	147161222	3/4" (20.0 mm)	5080 PSI (350 bar)	23.0	82.0	31.2	15.0	43.0
<b>NIPPLE, 1"</b>	147161626	1" (26.2 mm)	3630 PSI (250 bar)	30.0	100.5	38.5	21.0	54.0

All measurements are in mm. Check with an authorized CEJN distributor for availability and prices. Please visit our website, [www.cejn.com](http://www.cejn.com), for general maintenance tips.

# Plug – Female plug

Series 721 features Plug nipples in size 1/4" to 3/8"

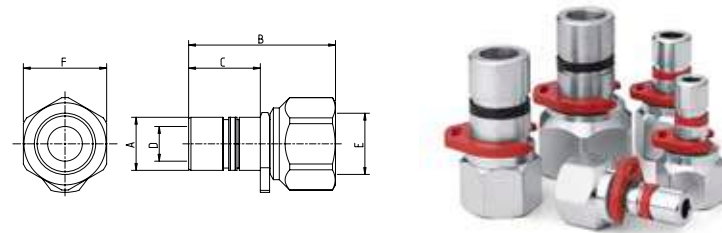

**TECHNICAL DATA**  
 Material nipple..... Hardened steel  
 Temperature range ..... -22°F – +212°F (-30°C – +100°C)

Part No.	Connection	Max working pressure	A	B	C	D	F	
<b>NIPPLE, 3/8"</b>	147210606	G 3/8" (10.1 mm)	5080 PSI (350 bar)	13.0	48.0	22.0	7.0	27.0
	147210608	G 1/2" (13.6 mm)	5080 PSI (350 bar)	13.0	52.0	22.0	7.0	30.6
<b>NIPPLE, 1/2"</b>	147210806	G 3/8" (10.1 mm)	5080 PSI (350 bar)	16.0	49.5	22.0	9.5	30.6
	147210808		3630 PSI (250 bar)	16.0	50.0	22.0	9.5	30.6
	147210848	G 1/2" (13.6 mm)	5080 PSI (350 bar)	16.0	50.0	22.0	9.5	30.6
<b>NIPPLE, 3/4"</b>	147211208	G 1/2" (13.6 mm)	5080 PSI (350 bar)	23.0	60.2	31.2	15.0	30.6
	147211212	G 3/4" (20.0 mm)	5080 PSI (350 bar)	23.0	63.5	31.0	15.0	40.0

All measurements are in mm. Check with an authorized CEJN distributor for availability and prices. Please visit our website, [www.cejn.com](http://www.cejn.com), for general maintenance tips.

# Plug – Male Plug

Series 723 features Plug-In stop nipples in size 1/4" to 1"

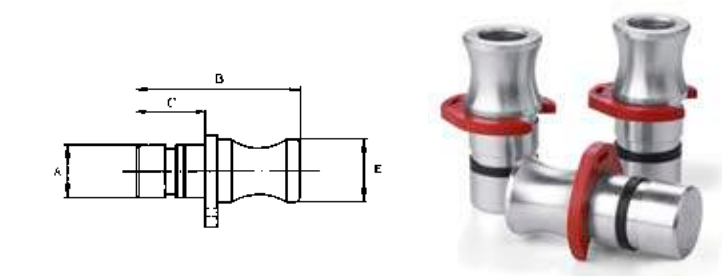

**TECHNICAL DATA**  
 Material nipple..... Hardened steel  
 Temperature range ..... -22°F – +212°F (-30°C – +100°C)

Part No.	Connection	Max working pressure	A	B	C	E	
<b>NIPPLE, 1/4"</b>	147230400	-	5080 PSI (350 bar)	10.0	43.0	19.0	12.0
<b>NIPPLE, 3/8"</b>	147230600	-	5080 PSI (350 bar)	13.0	50.0	22.0	16.0
<b>NIPPLE, 1/2"</b>	147230800	-	5080 PSI (350 bar)	16.0	50.0	22.0	19.0
<b>NIPPLE, 3/4"</b>	147231200	-	5080 PSI (350 bar)	23.0	59.0	31.0	25.0
<b>NIPPLE, 1"</b>	147231600	-	3630 PSI (250 bar)	30.0	75.0	38.5	33.0

All measurements are in mm. Check with an authorized CEJN distributor for availability and prices. Please visit our website, [www.cejn.com](http://www.cejn.com), for general maintenance tips.

# Plug – Male Plug G-thread

Series 724 features Plug-In stop nipples in size 1/4" to 1"

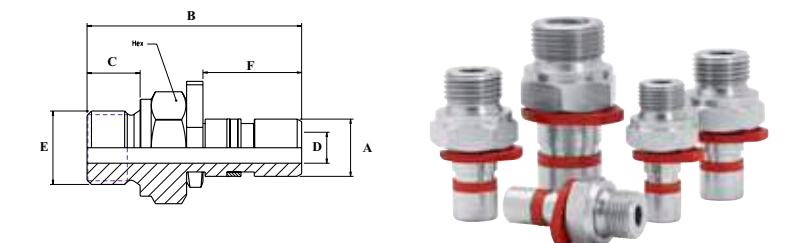

**TECHNICAL DATA**  
 Material nipple..... Hardened steel  
 Temperature range ..... -22°F – +212°F (-30°C – +100°C)

Part No.	Connection	Max working pressure	A	B	C	D	F	
<b>NIPPLE, 1/4"</b>	147240404	G 1/4" (6.9 mm)	5080 PSI (350 bar)	10.0	43.0	12.0	4.5	19.3
<b>NIPPLE, 3/8"</b>	147240606	G 3/8" (10.1 mm)	5080 PSI (350 bar)	13.0	43.0	12.0	7.0	22.0
<b>NIPPLE, 1/2"</b>	147240808	G 1/2" (13.6 mm)	5080 PSI (350 bar)	16.0	52.0	14.0	9.5	22.5
<b>NIPPLE, 3/4"</b>	147241212	G 3/4" (20.0 mm)	5080 PSI (350 bar)	23.0	65.0	16.0	15.0	31.2
<b>NIPPLE, 1"</b>	147241616	G 1" (26.2 mm)	3630 PSI (250 bar)	30.0	77.0	38.5	21.5	41.0

All measurements are in mm. Check with an authorized CEJN distributor for availability and prices. Please visit our website, [www.cejn.com](http://www.cejn.com), for general maintenance tips.

# Plug – Male Plug JIC 37°

Series 727 features Plug-In stop nipples in size 1/4" to 3/4"

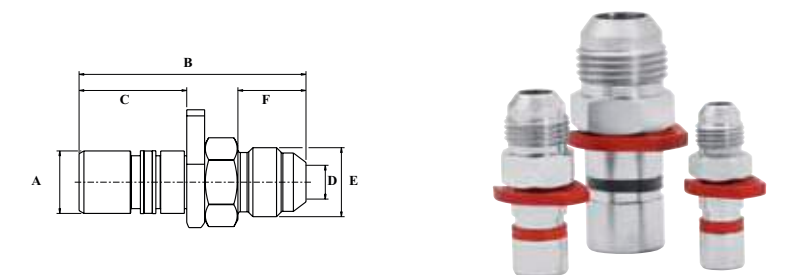

**TECHNICAL DATA**  
 Material nipple..... Hardened steel  
 Temperature range ..... -22°F – +212°F (-30°C – +100°C)

Part No.	Connection	Max working pressure	A	B	C	D	F	
<b>NIPPLE, 1/4"</b>	147270407	7/16" -20 UNF Male	5080 PSI (350 bar)	10.0	42.0	19.0	4.4	13.0
<b>NIPPLE, 3/8"</b>	147270609	9/16"-18 UNF	3630 PSI (250 bar)	13.0	47.0	22.3	7.0	14.0
	147270612	3/4"-16 UNF	3630 PSI (250 bar)	13.0	53.0	22.3	7.0	17.0
<b>NIPPLE, 1/2"</b>	147270809	9/16" - 18 UNF	5080 PSI (350 bar)	13.0	47.0	22.3	7.0	16.0
	147270812	3/4"-16 UNF	3630 PSI (250 bar)	16.0	52.0	22.0	9.5	20.0
	147270813	7/8" - 14 UNF	5080 PSI (350 bar)	16.0	55.0	22.0	9.0	-
	147270817	1 1/16" - 12 UNF	5080 PSI (350 bar)	16.0	62.0	22.0	9.5	-
<b>NIPPLE, 1"</b>	147271217	1 1/16" - 12 UNF	2900 PSI (200 bar)	23.0	68.0	31.0	15.0	27.0

All measurements are in mm. Check with an authorized CEJN distributor for availability and prices. Please visit our website, [www.cejn.com](http://www.cejn.com), for general maintenance tips.

# Couplings – External G-Thread (ISO 228/1)

Series 810 features Plug-In couplings with external G-thread (ISO 228/1) in sizes 1/4" up to 1"

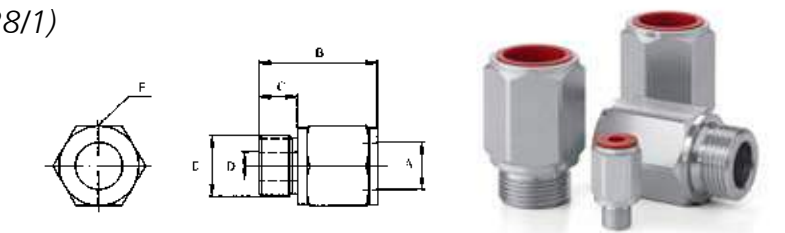

**TECHNICAL DATA**  
 Material coupling..... Hardened steel  
 Temperature range ..... -22°F – +212°F (-30°C – +100°C)

Part No.	Connection	Max working pressure	A	B	C	D	F	
<b>COUPLING, 1/4"</b>	148100404	G 1/4"	5080 PSI (350 bar)	10.0	38.4	12.0	4.5	20.0
	148100454	G 1/4" (6.9 mm)	5080 PSI (350 bar)	-	-	-	-	-
<b>COUPLING, 3/8"</b>	148100606	G 3/8"	5080 PSI (350 bar)	13.0	41.9	12.0	7.0	24.0
<b>COUPLING, 1/2"</b>	148100808	G 1/2"	5080 PSI (350 bar)	16.0	43.5	14.0	9.5	28.0
<b>COUPLING, 3/4"</b>	148101212	G 3/4"	5080 PSI (350 bar)	23.0	56.0	16.0	9.5	36.0
<b>COUPLING, 1"</b>	148101616	G 1"	3630 PSI (250 bar)	30.0	67.0	18.0	21.0	41.0

Thread connections are listed according to ISO Standards. All measurements are in mm. Check with an authorized CEJN distributor for availability and prices. Please visit our website, [www.cejn.com](http://www.cejn.com), for general maintenance tips.



## Couplings – Female plug

Series 811 features Plug-In stop coupling in sizes 1/4" up to 1"

### TECHNICAL DATA

Material coupling..... Hardened steel  
 Temperature range ..... -22°F – +212°F (-30°C – +100°C)

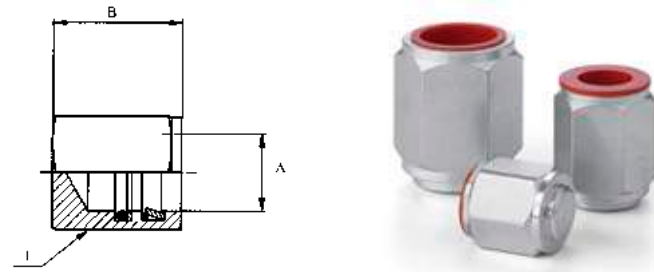

	Part No.	Connection	Max working pressure	A	B	F
COUPLING, 1/4"	148110400	-	5080 PSI (350 bar)	10.0	29.4	20.0
COUPLING, 3/8"	148110600	-	5080 PSI (350 bar)	13.0	31.3	24
COUPLING, 1/2"	148110800	-	5080 PSI (350 bar)	16.0	32.3	28
COUPLING, 3/4"	148111200	-	5080 PSI (350 bar)	23.0	44.0	32.0
COUPLING, 1"	148111600	-	3630 PSI (250 bar)	30.0	55.0	41.0

All measurements are in mm. Check with an authorized CEJN distributor for availability and prices. Please visit our website, [www.cejn.com](http://www.cejn.com), for general maintenance tips.

## Couplings – Bulkhead

Series 813 features Plug-In bulkhead couplings in sizes 1/4" up to 1/2"

### TECHNICAL DATA

Material coupling..... Hardened steel  
 Temperature range ..... -22°F – +212°F (-30°C – +100°C)

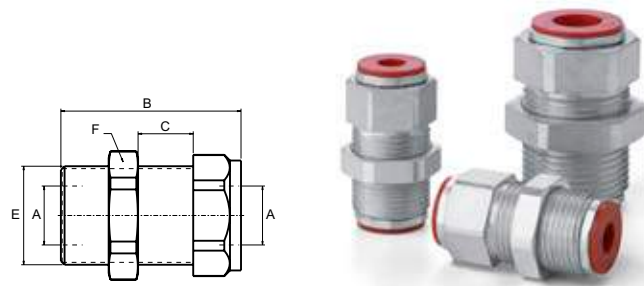

	Part No.	Connection	Max working pressure	A	B	C	F
COUPLING, 1/4"	148130444	M20x1.5	5080 PSI (350 bar)	10.0	42.8	0-18	22
COUPLING, 3/8"	148130646	M26x1.5	5080 PSI (350 bar)	13.0	50.8	0-25	27
COUPLING, 1/2"	148130848	M30x2	5080 PSI (350 bar)	16.0	50.0	0-25	32
COUPLING, 1"	148131646	M45x2	5080 PSI (350 bar)	30.0	84.0	0-25	50.0

All measurements are in mm. Check with an authorized CEJN distributor for availability and prices. Please visit our website, [www.cejn.com](http://www.cejn.com), for general maintenance tips.

## Couplings – Straight Hose Connection

Series 817 features Plug-In couplings with straight hose connections for one/two wire braided hydraulic hose in sizes 1/4" up to 1"

### TECHNICAL DATA

Material coupling..... Hardened steel  
 Temperature range ..... -22°F – +212°F (-30°C – +100°C)

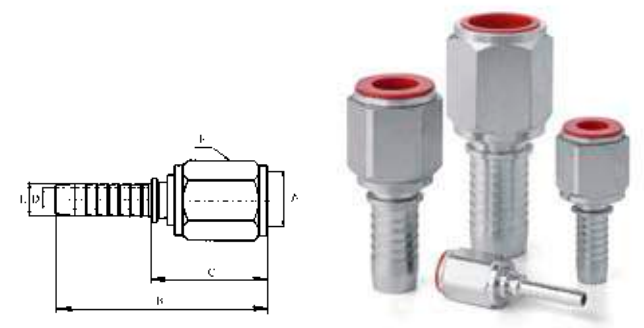

	Part No.	Connection	Max working pressure	A	B	C	D	F
COUPLING, 1/4"	148170404	3/16" (5.25 mm)	5080 PSI (350 bar)	10.0	58.5	33.2	2.8	20
COUPLING, 3/8"	148170606	3/8" (10.1 mm)	5080 PSI (350 bar)	13.0	66.9	36.0	7.0	24
COUPLING, 3/4"	148171212	3/4" (20 mm)	5080 PSI (350 bar)	23.0	87.0	48.0	15.0	32
COUPLING, 1"	148171616	1" (26.2 mm)	3630 PSI (250 bar)	30.0	105.0	58.5	21.0	41

All measurements are in mm. Check with an authorized CEJN distributor for availability and prices. Please visit our website, [www.cejn.com](http://www.cejn.com), for general maintenance tips.

## Couplings – SAE J514 O-Ring Boss

Series 826 features Plug-In couplings SAE J514 O-ring Boss in sizes 1/4" up to 1"

### TECHNICAL DATA

Material coupling..... Hardened steel  
 Temperature range ..... -22°F – +212°F (-30°C – +100°C)

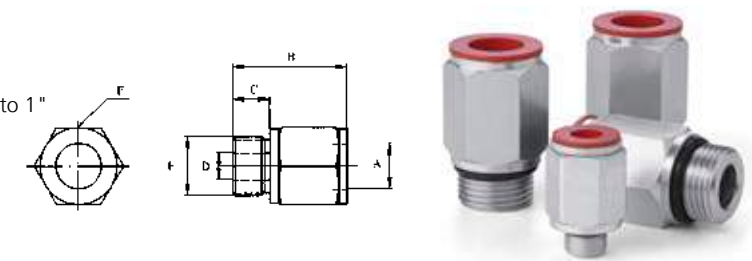

	Part No.	Connection	Max working pressure	A	B	C	D	F
COUPLING, 1/4"	148260407	7/16"-20	5080 PSI (350 bar)	10.0	35.4	9.0	4.5	20
COUPLING, 3/8"	148260609	9/16"-18	5080 PSI (350 bar)	13.0	39.9	10.0	7.0	24
COUPLING, 1/2"	148260812	3/4"-16	5080 PSI (350 bar)	16.0	40.5	11.0	9.5	28
	148260814	7/8"-14	5080 PSI (350 bar)	16.0	42.1	12.6	12.7	28
	148260817	1 1/16"-12	5080 PSI (350 bar)	16.0	44.5	15.0	14.5	28
COUPLING, 3/4"	148261217	1 1/16"-12	5080 PSI (350 bar)	23.0	55.0	15.0	15.0	32
COUPLING, 1"	148261621	1 5/16"-12	3630 PSI (250 bar)	30.0	64.0	15.0	21.0	41

Thread connections are listed according to SAE Standards. All measurements are in mm. Check with an authorized CEJN distributor for availability and prices. Please visit our website, [www.cejn.com](http://www.cejn.com), for general maintenance tips.

## Couplings – External G-Thread with Integral Rubber Seal

Series 830 features Plug-In couplings with external G-thread with integral rubber seal in sizes 1/4" up to 1"

### TECHNICAL DATA

Material coupling..... Hardened steel  
 Temperature range ..... -22°F – +212°F (-30°C – +100°C)

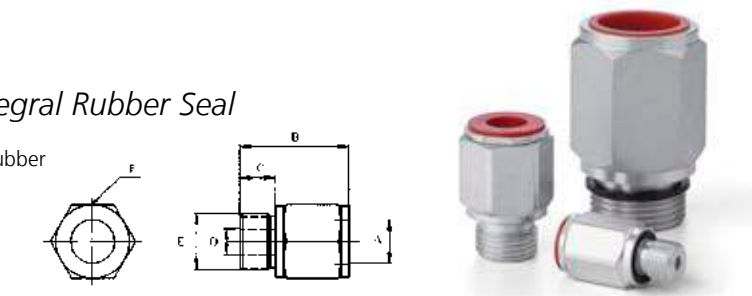

	Part No.	Connection	Max working pressure	A	B	C	D	F
COUPLING, 1/4"	148300404	G 1/4"	5080 PSI (350 bar)	10.0	38.0	12.0	4.5	20
COUPLING, 3/8"	148300606	G 3/8"	5080 PSI (350 bar)	13.0	41.0	12.0	7.0	24
COUPLING, 1/2"	148300808	G 1/2"	5080 PSI (350 bar)	16.0	43.0	14.0	9.5	28
COUPLING, 3/4"	148301212	G 3/4"	5080 PSI (350 bar)	23.0	56.0	16.0	15.0	34
COUPLING, 1"	148301616	G 1"	3630 PSI (250 bar)	30.0	69.0	18.0	21.0	41

Thread connections are listed according to ISO Standards. All measurements are in mm. Check with an authorized CEJN distributor for availability and prices. Please visit our website, [www.cejn.com](http://www.cejn.com), for general maintenance tips.

## Couplings. – Metric (ISO 6149-3)

Series 831 features Plug-In couplings with external metric thread (ISO 6149 - 3) in sizes 1/4" up to 3/4"

### TECHNICAL DATA

Material coupling..... Hardened steel  
 Temperature range ..... -22°F – +212°F (-30°C – +100°C)

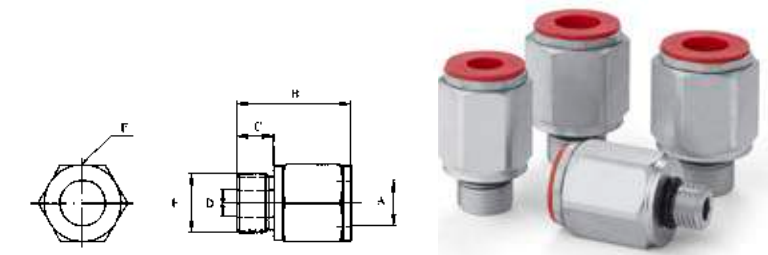

	Part No.	Connection	Max working pressure	A	B	C	D	F
COUPLING, 1/4"	148310414	G 1/4" male	5080 PSI (350 bar)	10.0	37.0	11.0	7.5	20
COUPLING, 3/8"	148310612	M18x1.5	4570 PSI (315 bar)	16.0	42.0	12.5	9.5	27
	148310616	M16x1.5	4570 PSI (315 bar)	13.0	41.4	11.5	7.5	24
COUPLING, 1/2"	148310818	M18x1.5	4570 PSI (315 bar)	16.0	42.0	12.5	9.5	27
COUPLING, 3/4"	148311222	M22x1.5	4570 PSI (315 bar)	23.0	53.0	13.0	14.0	32
	148311227	M27x2	2900 PSI (200 bar)	23.0	56.0	16.0	15.0	32

Thread connections are listed according to ISO Standards. All measurements are in mm. Check with an authorized CEJN distributor for availability and prices. Please visit our website, [www.cejn.com](http://www.cejn.com), for general maintenance tips.

# WEO Plug-In swivel

WEO Plug-In swivel absorbs the movement in the hydraulic hose

The WEO Plug-In swivel is a plug-in connector with integrated swivel function, where the design absorbs back and forth swivel movements. The WEO Plug-In swivel can be turned 360° and is specially adapted for a modern compact hydraulic system. The product is as small and flexible as our base version of WEO Plug-In but swivels freely up to full working pressure.

## Coupling – Swivel

Series 860 features Plug-In swivel couplings with external G-thread with internal rubber seal in sizes 3/8" up to 1"

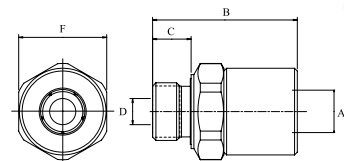

### TECHNICAL DATA

**Material coupling**..... Steel (Galvanic Zn-Ni with Cr6 free passivation)  
**Temperature range** ..... -22°F – +212°F (-30°C – +100°C)

Part No.	Connection	Max working pressure	A	B	C	D	F
<b>COUPLING, 3/8"</b>	G 3/8"	5080 PSI (350 bar)	13.0	47.1	12.0	7.0	27
<b>COUPLING, 1/2"</b>	G 1/2"	5080 PSI (350 bar)	16.0	52.6	14.0	9.5	32
<b>COUPLING, 3/4"</b>	G 3/4"	5080 PSI (350 bar)	23	67	16	15	41
<b>COUPLING, 1"</b>	G 1"	3630 PSI (250 bar)	30.0	74.6	16.0	21.0	50

Thread connections are listed according to ISO Standards. All measurements are in mm. Check with an authorized CEJN distributor for availability and prices. Please visit our website, www.cejn.com, for general maintenance tips.

# WEO Plug-In Cartridge

Hydraulic Fitting Technology – Made Easy and Cost-Effective

### GET FLEXIBILITY!

WEO Plug-In Cartridge is a flexible cartridge that can be integrated in all kinds of hydraulic components, such as valves, filters, pumps and motors. One cartridge fits all applications, opening up new possibilities for both component and equipment manufacturers. No special design is necessary; just integrate the cartridge into the hydraulic component (see drill pattern illustration on next page).

### NEW OPPORTUNITIES!

The WEO Plug-In Cartridge opens up new opportunities where ever you are in the manufacturing chain. Whether you supply the component or the finished equipment, the Cartridge gives you great opportunities to supply an "easy-to-install, easy-to-service" component or machine. Integrating the fitting into the component in an early stage saves time and money every step of the way. No more sub-assemblies or re-tightening of hard to reach screw-fittings or time-consuming leakage tests. Can you think of a better way to support your customer?

### CUT YOUR SPACE REQUIREMENTS!

The WEO Plug-In Cartridge gives you new possibilities to design smaller valves, filters, pumps, motors etc. Integrating the fitting means eliminating space requirements for adapters or other fittings. All you need to account for is the space required for a small screwdriver to reach the hose connector. With more and more complex equipment any space savings made means cost savings in the end not to mention a leaner and more attractive piece of equipment. Could you pass up an opportunity like that?



## EQUIPMENT MANUFACTURERS

Using components with integrated WEO Plug-In cartridges will make your assembly easier and faster. You no longer need to assemble adapters or female fittings before attaching the hose or to re-tighten the hose fittings after assembly, thus also minimizing work-related injuries. The WEO Plug-In click-to-connect feature also opens up for more compact system designs. Adding up to extensive cost savings!

## COMPONENT MANUFACTURERS

Integrating the WEO Plug-In Cartridge in your components means selling and delivering cost saving benefits to your customer. With no adapters or female fittings necessary for assembly you'll also make your own testing procedures quick and easy without compromising quality. Adding up to cost savings and new business opportunities!

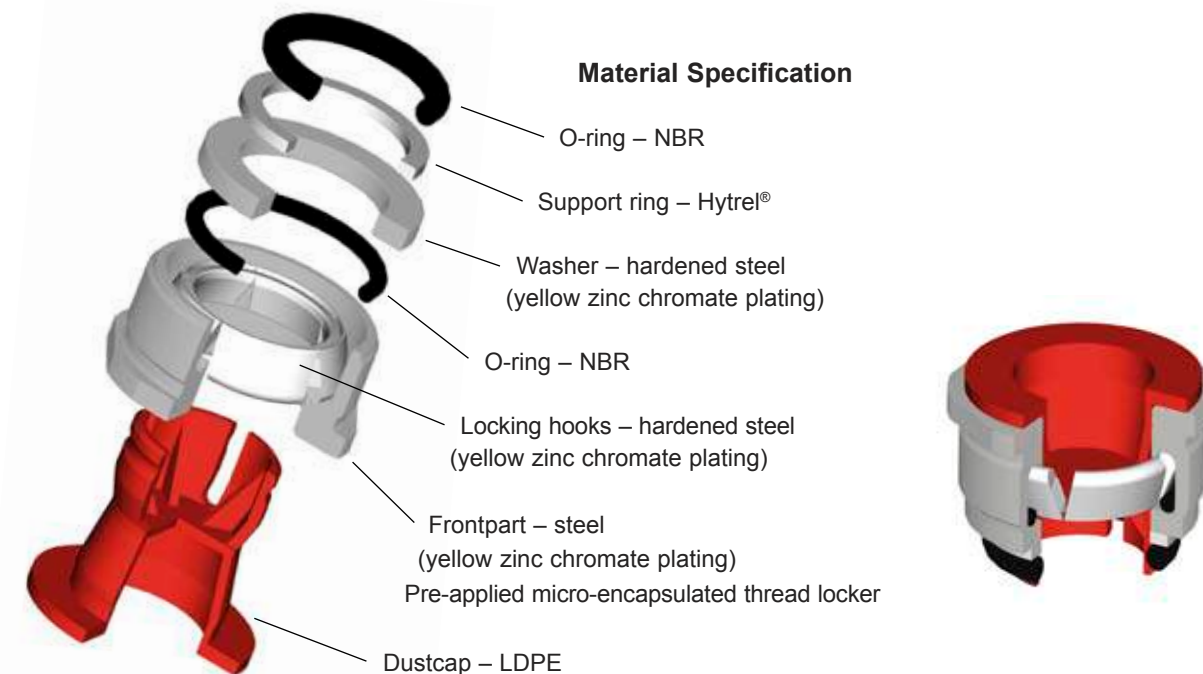

### Material Specification

- O-ring – NBR
- Support ring – Hytrel®
- Washer – hardened steel (yellow zinc chromate plating)
- O-ring – NBR
- Locking hooks – hardened steel (yellow zinc chromate plating)
- Frontpart – steel (yellow zinc chromate plating)
- Pre-applied micro-encapsulated thread locker
- Dustcap – LDPE

## Cartridge – Plug-In Cartridge

WEO Plug-In Cartridge is a flexible cartridge that can be integrated in all kinds of hydraulic components, such as valves, filters, pumps and motors. One cartridge fits all applications, opening up new possibilities for both component and equipment manufacturers. No special design is necessary; just integrate the cartridge into the hydraulic component.

### TECHNICAL DATA

**Material coupling**..... Steel (zinc passivation, Cr6 free passivation)  
**Max. working pressure**..... 5080 PSI (350 bar)  
**Min. burst pressure**..... 20310 PSI (1400 bar)  
**Temperature range** ..... -22°F – +212°F (-30°C – +100°C)

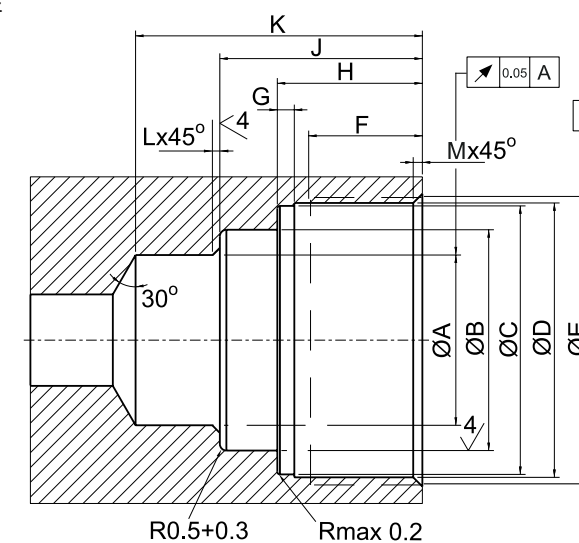

Part No.	A	B	C	D	E	F	G	H	J	K	Rec. torque
<b>CARTRIDGE</b>											
148000600	13.03+0.08	16.95+0.15	20.55+0.07	21.0+0.1	M22x1	8.7+1	1.15-0.1	11.1+0.1	15.5+0.2	21.95+0.15	30-40 Nm Nm
148000680	13.03+0.08	16.95+0.15	20.55+0.07	21.0+0.1	M22x1	8.7+1	1.15-0.1	11.1+0.1	15.5+0.2	21.95+0.15	30-40 Nm Nm
148000400	10.03+0.08	12.75+0.1	16.55+0.07	17.0+0.1	M18x1	8.5+1	1.1-0.1	10.65+0.1	14.15+0.2	19.65+0.15	25-35 Nm Nm
148000800	16.03+0.08	19.95+0.15	23.55+0.07	24.0+0.1	M25x1	8.7+1	1.25-0.1	11.3+0.1	15.7+0.2	22.15+0.15	40-50 Nm Nm
148001200	23.03+0.08	27.95+0.15	31.05+0.07	31.5+0.1	M33x1.5	11.5+1	1.7-0.1	16.5+0.1	21.4+0.2	31.35+0.15	70-80 Nm Nm

Thread connections are listed according to ISO Standards. All measurements are in mm.



*The Global*  
**Quick Connect Specialist**

