

# Solenoid directional valves type DHE and DHER

direct operated, ISO 4401 size 06

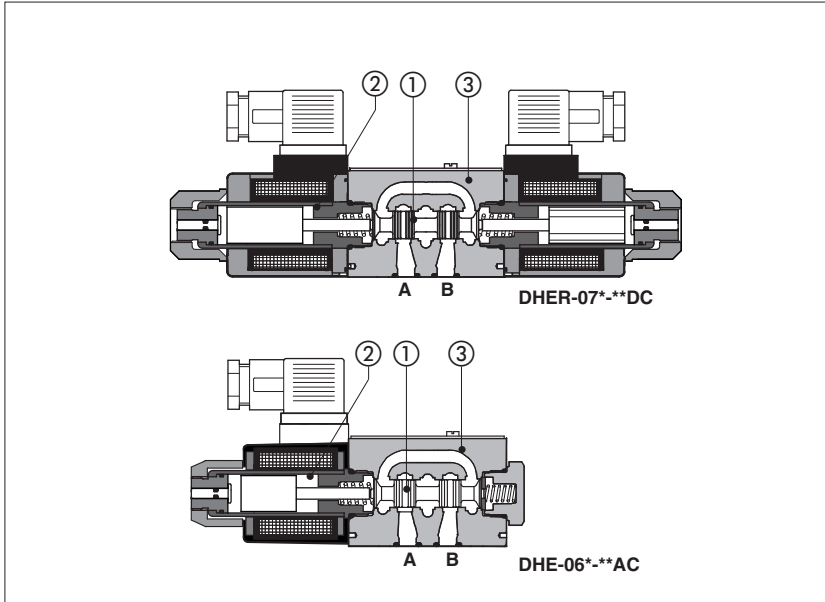

Spool type, direct operated solenoid valves available in two different versions:

- DHE** equipped with threaded type, high performance solenoids
- DHER** as DHE but with solenoids certified according to the North American standard **cURus**

### Configurations and construction

The valves are available in three or four way configurations and with two or three spool positions, see section 2. The spools ① are interchangeable and they are available in a wide range of hydraulic configurations, see section 3. The solenoids ② have two different executions for AC or DC power supply and they are composed by:

- wet type screwed tube with integrated manual override pin d (the tube are different for AC and DC power supply).
- AC and DC coils see section 5

The coils are interchangeable for the same type of power supply AC or DC and they can be easily replaced without tools (they are not interchangeable between DHE and DHER)

The coils are fully encapsulated with the following temperature classes:

- class H for DC coils
- class F for AC coils

The valve body ③ is 3 chamber type made by shell-moulding casting.

### Options

The following optional devices are available for DHE and DHER:

- prolonged manual override protected with rubber cap for easy hand operation
- control devices of the valve switching time
- spool position monitor devices for safety applications

**Surface mounting ISO 4401 size 06.**

**Max flow up to 80 l/min**

**Max pressure: 350 bar.**

## 1 MODEL CODE

**DHE - 0 63 1/2 /A - X 24 DC \*\* /\***

Directional control valves size 06  
**DHE** = AC and DC supply, threaded solenoids, high performances  
**DHER** = as DHE but **cURus** certified solenoids

Valve configuration, see table 2

- 61** = single solenoid, center plus external position, spring centered
- 63** = single solenoid, 2 external positions, spring offset
- 67** = single solenoid, center plus external position, spring offset
- 70** = double solenoid, 2 external positions, without springs
- 71** = double solenoid, 3 positions, spring centered
- 75** = double solenoid, 2 external positions, with detent

Spool type, see table 3.

**Note:** configurations 63 is available only with spools type 0/2, 1/2 and 2/2.  
 configurations 75 is available only with spools type 0/2, and 1/2.

Synthetic fluids  
**WG** = water glycol  
**PE** = phosphate ester

Series number

Voltage code, see section 5

- 00** = valve without coil
  - X** = without connector
- See note 2 at section 5 for available connectors, to be ordered separately  
 Coils with special connectors, see section 7
- XJ** = AMP Junior Timer connector
  - XK** = Deutsch connector
  - XS** = Lead Wire connection

Options, see note 1 at section 5.

## 2 CONFIGURATION

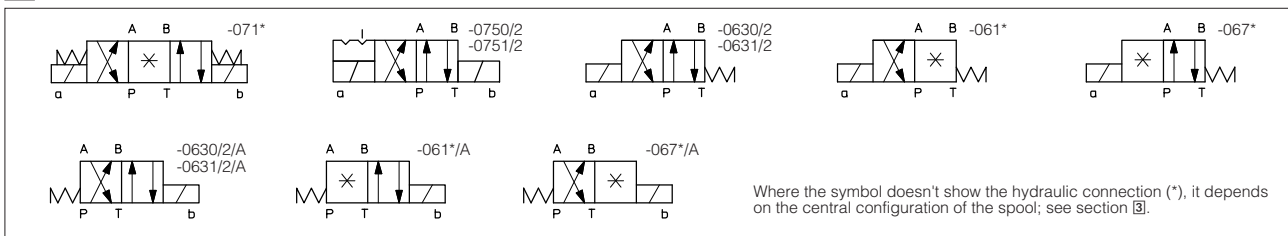

## 3 SPOOLS - for intermediate passages, see tab. E001.

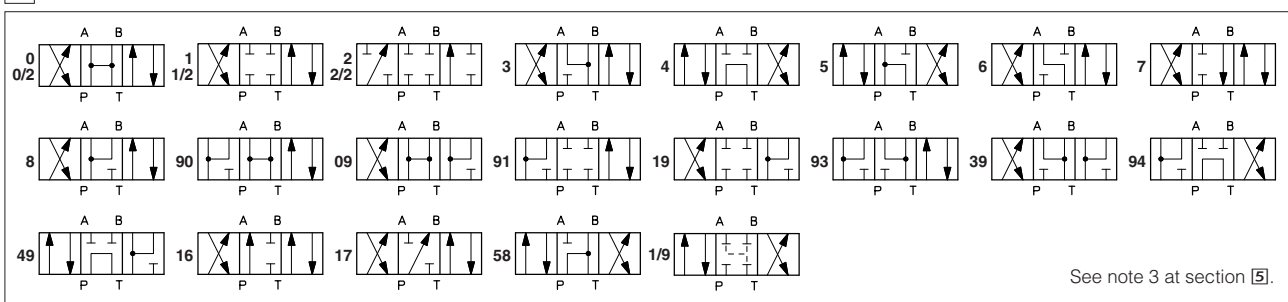

See note 3 at section 5.

#### 4 MAIN CHARACTERISTICS OF SDHE DIRECTIONAL VALVES

Assembly position / location	Any position for all valves except for type - 070° (without springs) that must be installed with horizontal axis if operated by impulses
Subplate surface finishing	Roughness index $\sqrt{0.4}$ flatness ratio 0,01/100 (ISO 1101)
Ambient temperature	from -20°C to +70°C
Fluid	Hydraulic oil as per DIN 51524 .... 535; for other fluids see section 1
Recommended viscosity	15 ÷ 100 mm <sup>2</sup> /s at 40°C (ISO VG 15 ÷ 100)
Fluid contamination class	ISO 19/16, achieved with in line filters at 25 µm value to $\beta_{25} \geq 75$ (recommended)
Fluid temperature	-20°C +60°C (standard and /WG seals) -20°C +80°C (/PE seals)
Flow direction	As shown in the symbols of tables 2 and 3
<b>Operating pressure</b>	Ports P,A,B: <b>350 bar</b> ; Port T <b>210 bar</b> for DC version; <b>160 bar</b> for AC version
Rated flow	See diagrams Q/ $\Delta p$ at section 8
<b>Maximum flow</b>	<b>80 l/min</b> , see operating limits at section 9

#### 4.1 Coils characteristics

Insulation class	H (180°C) Due to the occurring surface temperatures of the solenoid coils, the European standards EN563 and EN982 must be taken into account
Connector protection degree DIN 43650	IP 65
Relative duty factor	100%
Supply voltage and frequency	See electric feature 6
Supply voltage tolerance	± 10%
Certification (only for DHER)	<b>cURus</b> North American Standard

#### 5 NOTES

##### 1 Options

**A** = Solenoid mounted at side of port B (only for single solenoid valves). In standard versions, solenoid is mounted at side of port A.

**WP** = prolonged manual override protected by rubber cap - see section 11.

**SP-WPD/HS-DC** = (only for DHE-DC) manual override with detent, to be ordered separately, see tab. K150

**L1, L2, L3** = device for switching time control, installed in the valve solenoid.

For spools 4 and 4/8 only device L3 is available.

**F\*** = with proximity switch for monitoring spool position: see tab. E110.

**MV, MO** = auxiliary hand lever positioned vertically (MV) or horizontally (MO). For available configuration and dimensions see table E138.

##### 2 Type of electric/electronic connector DIN 43650, to be ordered separately

**SP-666** = standard connector IP-65, suitable for direct connection to electric supply source.

**SP-667** = as SP-666, but with built-in signal led.

##### 3 Spools

- spools type **0/2, 1/2, 2/2** are only used for two position valves: single solenoid, type SDHE-063\*/2 and double solenoid type SDHE-075\*/2 (only spools 0/2 and 1/2).

- spools type **0** and **3** are also available as **0/1** and **3/1** with restricted oil passages in central position, from user ports to tank.

- spools type **1, 4, 5** and **58** are also available as **1/1, 4/8, 5/1** and **58/1**. They are properly shaped to reduce water-hammer shocks during the swiching.

- spools type **1, 1/2, 3, 8** are available as **1P, 1/2P, 3P, 8P** to limit valve internal leakages.

- Other types of spools can be supplied on request.

#### 6 ELECTRIC FEATURES

External supply nominal voltage ± 10%	Voltage code	Type of connector	Power consumption (2)	Code of spare coil DHE	Code of spare coil DHER		
12 DC	<b>12 DC</b>	SP-666 or SP-667	30 W	SP-COE-12DC /10	SP-COER-12DC /10		
14 DC	<b>14 DC</b>			SP-COE-14DC /10	SP-COER-14DC /10		
24 DC	<b>24 DC</b>			SP-COE-24DC /10	SP-COER-24DC /10		
28 DC	<b>28 DC</b>			SP-COE-28DC /10	SP-COER-28DC /10		
48 DC	<b>48 DC</b>			SP-COE-48DC /10	SP-COER-48DC /10		
110 DC	<b>110 DC</b>			SP-COE-110DC /10	SP-COER-110DC /10		
125 DC	<b>125 DC</b>			SP-COE-125DC /10	SP-COER-125DC /10		
220 DC	<b>220 DC</b>			SP-COE-220DC /10	SP-COER-220DC /10		
110/50 AC	<b>110/50/60 AC</b>			SP-669	58 VA (3)	SP-COE-110/50/60AC /10 (1)	SP-COER-110/50/60AC /10 (1)
230/50 AC	<b>230/50/60 AC</b>					SP-COE-230/50/60AC /10 (1)	SP-COER-230/50/60AC /10 (1)
115/60 AC	<b>115/60 AC</b>	SP-COE-115/60AC	SP-COER-115/60AC				
230/60 AC	<b>230/60 AC</b>	SP-COE-230/60AC	SP-COER-230/60AC				
110/50 AC - 120/60 AC	<b>110 RC</b>	SP-COE-110RC	SP-COER-110RC				
230/50 AC - 230/60 AC	<b>230 RC</b>	SP-COE-230RC	SP-COER-230RC				

(1) Coil can be supplied also with 60 Hz of voltage frequency: in this case the performances are reduced by 10 ÷ 15% and the power consumption is 52 VA.

(2) Average values based on tests preformed at nominal hydraulic condition and ambient/coil temperature of 20°C.

(3) When solenoid is energized, the inrush current is approx 3 times the holding current. Inrush current values correspond to a power consumption of about 160 VA.

#### 7 COILS WITH SPECIAL CONNECTORS

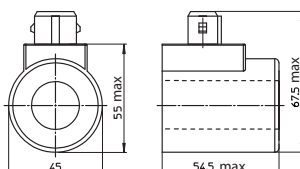
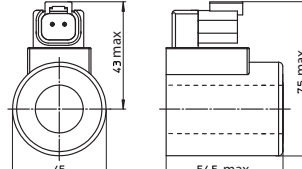
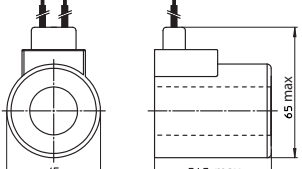
AMP Junior timer connector	Deutsch connector DT-04-2P	Lead Wire connection
 <p><b>Options -XJ</b> Coil type SP-COEJ (DHE) SP-COERJ (DHER) AMP Junior Timer connector Protection degree IP67</p>	 <p><b>Options -XK</b> Coil type SP-COEK (DHE) SP-COERK (DHER) Deutsch connector DT-04-2P male Protection degree IP67</p>	 <p><b>Options -XS</b> Coil type SP-COES (DHE) SP-COERS (DHER) Lead Wire connection Cable lenght = 180 mm</p>

Note: The above coils are available only for voltage supply **12, 14, 24** and **28 Vdc**. For the characteristics refer to standard coils features - see sect. 6

**8 Q/ΔP DIAGRAMS** based on mineral oil ISO VG 46 at 50°C

Flow direction Spool type	P→A	P→B	A→T	B→T	P→T
	0, 0/1	A	A	C	C
1, 1/1	D	C	C	C	
3, 3/1	D	D	A	A	
4, 4/8, 5, 5/1, 58, 58/1	F	F	G	C	E
1/2, 0/2	D	D	D	D	
6, 7	D	D	D	D	
8	A	A	E	E	
2	D	D			
2/2	F	F			

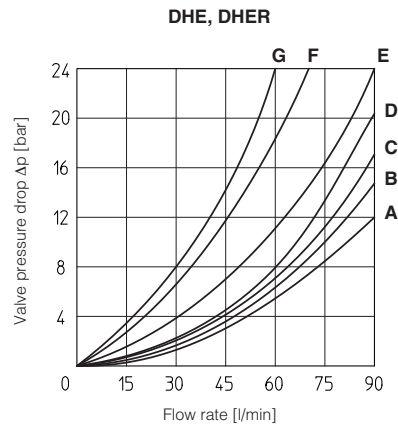

**9 OPERATING LIMITS** based on mineral oil ISO VG 46 at 50°C

The diagrams have been obtained with warm solenoids and power supply at lowest value ( $V_{nom} - 10\%$ ). The curves refer to application with symmetrical flow through the valve (i.e. P→A and B→T). In case of asymmetric flow and if the valves have the devices for controlling the switching times the operating limits must be reduced.

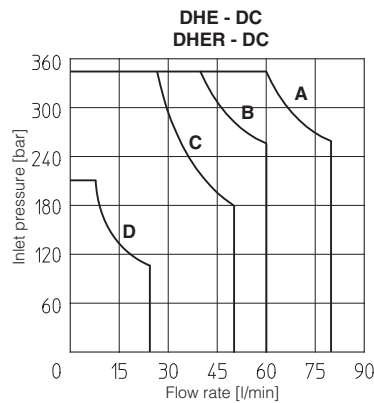
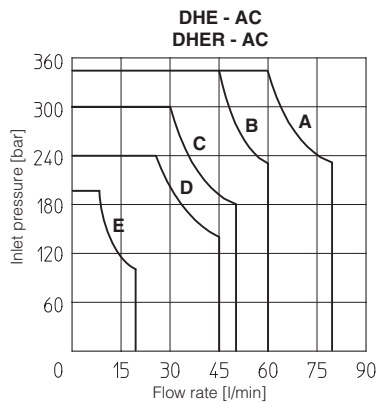

**DHE - AC  
DHER - AC**

- A = Spools 1, 1/2, 2, 8
- B = Spools 0, 0/1, 0/2, 1/1
- C = Spools 3, 3/1
- D = Spools 4, 4/8, 5, 5/1, 6, 7, 19, 39, 58, 58/1, 91, 93
- E = Spools 2/2

**DHE - DC  
DHER - DC**

- A = Spools 0, 0/1, 1, 1/2, 2, 3, 8
- B = Spools 0/2, 1/1, 6, 7
- C = Spools 3/1, 4, 4/8, 5, 5/1, 19, 39, 58, 58/1, 91, 93
- D = Spools 2/2

**10 SWITCHING TIMES** (average values in msec)

Valve	Switch-on AC	Switch-on DC	Switch-off
DHE	—	50	20
DHE-*/L1	—	60	60
DHE-*/L2	—	80	80
DHE-*/L3	—	150	150

Test conditions:

- 36 l/min; 150 bar
- nominal voltage
- 2 bar of counter pressure on port T
- mineral oil: ISO VG 46 at 50°C.

The elasticity of the hydraulic circuit and the variations of the hydraulic characteristics and temperature affect the response time.

**11 ELECTRIC CONNECTORS ACCORDING TO DIN 43650** The connectors must be ordered separately

SP-666, SP-667 (for AC or DC supply)	SP-669 (for AC supply)	CONNECTOR WIRING	
		<b>SP-666, SP-667</b> 1 = Positive ⊕ 2 = Negative ⊖ ⊕ = Coil ground	<b>SP-669</b> 1,2 = Supply voltage $V_{AC}$ 3 = Coil ground
		<b>SUPPLY VOLTAGES</b>	
<b>SP-666</b> All voltages	<b>SP-667</b> 24 AC or DC 110 AC or DC 220 AC or DC	<b>SP-669</b> 110/50 AC 110/60 AC 230/50 AC 230/60 AC	

**12 DIMENSIONS [mm]**

**ISO 4401: 2005**

**Mounting surface: 4401-03-02-0-05**

Fastening bolts: 4 socket head screws:

M5x30 class 12.9

Tightening torque = 8 Nm

Seals: 4 OR 108

Ports P,A,B,T:  $\varnothing = 7.5$  mm (max)

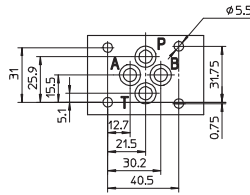

**P** = PRESSURE PORT  
**A, B** = USE PORT  
**T** = TANK PORT

**DHE-06(DC)**

Option /WP

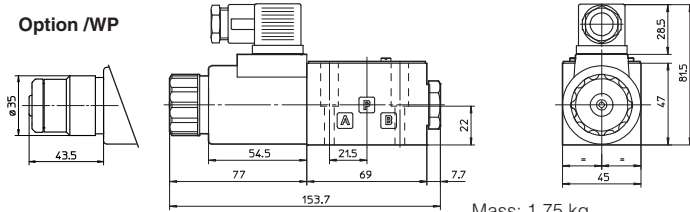

Mass: 1,75 kg

**DHE-07(DC)**

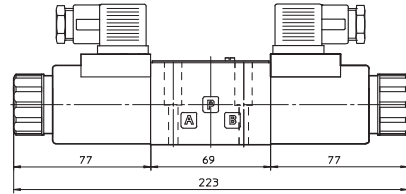

Mass: 2 kg

**DHE-06(AC)**

Option /WP

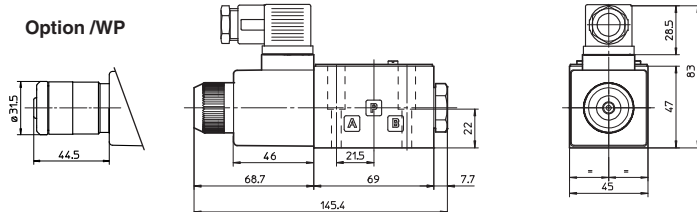

Mass: 1,6 kg

**DHE-07(AC)**

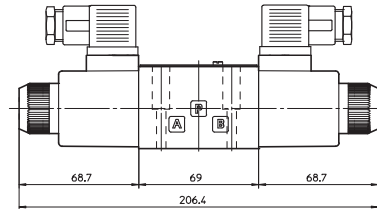

Mass: 1.9 kg

**DHER-06(DC)**

Option /WP

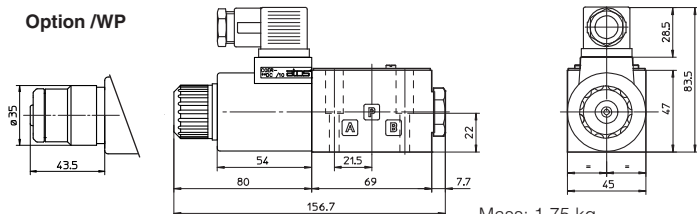

Mass: 1,75 kg

**DHER-07(DC)**

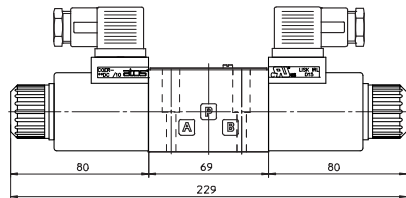

Mass: 2 kg

**DHER-06(AC)**

Option /WP

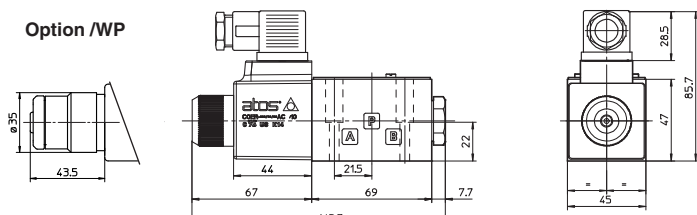

Mass: 1,6 kg

**DHER-07(AC)**

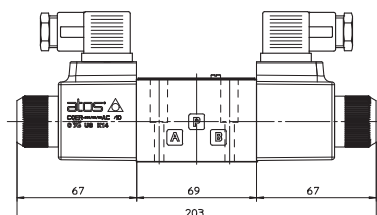

Mass: 1.9 kg

Overall dimensions refer to valves with connectors type SP-666

**14 MOUNTING SUBPLATES**

Model	Ports location	GAS Ports A-B-P-T	Ø Counterbore [mm] A-B-P-T	Mass [kg]
BA-202	Ports A, B, P, T underneath;	3/8"	-	1,2
BA-204	Ports P, T underneath; ports A, B on lateral side	3/8"	25,5	1,8
BA-302	Ports A, B, P, T underneath	1/2"	30	1,8

The subplates are supplied with 4 fastening bolts M5x50. Also available are multi-station subplates and modular subplates. For further details see table K280.