

Pressure relief and feed valve, pilot operated

Type MHDBN

RE 64602

Edition: 2013-02

Replaces: 2011-09



H7567

- ▶ Frame sizes 16, 22, 32
- ▶ Component series 3X
- ▶ Maximum operating pressure 420 bar
- ▶ Maximum flow 400 l/min

Features

- ▶ Screw-in cartridge valve
- ▶ For mobile applications
- ▶ Pressure ratings from 100 to 420 bar
- ▶ Available in 3 sizes (16, 22, 32)
- ▶ Versatile applications for pressure relief and feed functions

Contents

Features	1
Ordering code	2
Valve types	3
Function, section, symbol	4
Technical data	5
Characteristic curves	6 to 10
Unit dimensions	11
Mounting cavity	12 to 13
Available individual components	14

Ordering code

01	02	03	04	05	06	07	08	09	10	11	12
MH	DBN		K	-	3X	/					*

01	Mobile hydraulics	MH
----	-------------------	----

02	Pressure relief and feed valve, pilot operated ¹⁾	DBN
----	--	-----

03	Size 16	16
	Size 22	22
	Size 32	32

04	Screw-in cartridge valve	K
----	--------------------------	---

Adjustment type

05	Grub screw with internal hexagon	2
----	----------------------------------	---

06	Component series 30 to 39 (30 to 39: Unchanged installation and connection dimensions)	3X
----	--	----

Pressure rating ²⁾

07	Set pressure up to 100 bar	100
	Set pressure up to 420 bar	420

Pressure adjustment

08	Without pressure adjustment, without protective cap ³⁾	no code
	With pressure adjustment, with protective cap	... ⁴⁾

Pilot oil supply and pilot oil return

09	Internal pilot oil supply and pilot oil return	no code
----	--	---------

Seal material

10	NBR seals	M
	FKM seals	V
	(Other seals upon request) Attention! Observe compatibility of seals with hydraulic fluids used!	

Mounting cavity

11	M 24 x 1 (size 16)	FB
	M 24 x 1.5 (size 16)	FH
	M 28 x 1 (size 22)	FC
	M 30 x 1.5 (size 22)	LG
	1 3/16-12 UN-2B (size 22)	FW
	M 33 x 1 (size 32)	FK
	M 36 x 1 (size 32)	LM

12	Further details in the plain text	
----	-----------------------------------	--

- ¹⁾ Minimum cracking pressure see characteristic curves pages 6 to 10.
- ²⁾ The values refer to the screw-in cartridge valve. If the valve is installed in a housing, it has to be made sure that the set pressure of the screw-in cartridge valve does not exceed the value of the housing that might be lower!
- ³⁾ Protective cap separately available, material no. R900168151; valves whose pressure is not adjusted at the factory are delivered in pressure-relieved state.
- ⁴⁾ Example:
Set to 300 bar: ...420-**300**...
(pressure adjustment with $q_{Vmax} = 10$ l/min)

⚠ Attention! Factory-set valves are protected by means of a protective cap. In the case of subsequent re-adjustment, the warranty will become void!

Valve types

Type	Material no.	Mounting cavity (see pages 12 to 13)	Characteristic curves (see pages 6 to 10)
MHDBN 16 K2-3X/100VFB	R901161659	FB	D1 / E1
MHDBN 16 K2-3X/420VFB	R901161947	FB	D1 / E1
MHDBN 16 K2-3X/420VFH	R901162185	FH	D1 / E2
MHDBN 22 K2-3X/100VFC	R901162202	FC	D2 / E4
MHDBN 22 K2-3X/420VFC	R901162378	FC	D3 / E4
MHDBN 22 K2-3X/420VLG	R901162524	LG	D3 / E5
MHDBN 32 K2-3X/100VFK	R901162658	FK	D4 / E6
MHDBN 32 K2-3X/420VFK	R901162717	FK	D4 / E6
MHDBN 32 K2-3X/420VLM	R901162838	LM	D4 / E7

Function, section, symbol

General

The pressure valve type MHDBN is a pilot operated pressure relief valve for installation in block designs. It is used to limit a system pressure. The system pressure can be set steplessly via the adjustment spindle (4).

Pressure relief function

In the initial position the valve is closed. The pressure in main port ① acts on the spool (1). At the same time, pressure is applied to the spring-loaded side of the spool (1) and to the pilot poppet (6) via nozzle (2). If the pressure in main port ① exceeds the value set at spring (5), the pilot poppet (6) opens. Hydraulic fluid flows from the spring-loaded side of the spool (1), via nozzle (3) and channel (7), into the main port ② (tank). The resulting pressure drop moves the spool (1) and thus opens the connection from main port ① to ② while maintaining the pressure set at

spring (5). The pilot oil is returned internally, via channel (7), into main port ②.

Feed function

The feed function makes up for lacking oil volumes caused, for example, by leakage when pressure valves respond or in the case of leading loads.

If the pressure at main port ① is lower than the one at main port ②, the spool (1) will be lifted out of its seat. Hydraulic fluid flows from main port ② to main port ①.

Notice!

- The maximum operating pressure is added up from the set pressure and the return flow pressure at main port ②.
- The pilot operated pressure valves are virtually leakage oil-free thanks to their construction.

Symbol

Internal pilot oil supply and pilot oil return
"No code" version

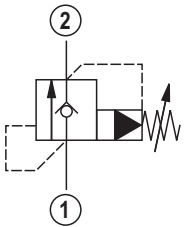

① = Main port 1 (P)

② = Main port 2 (T)

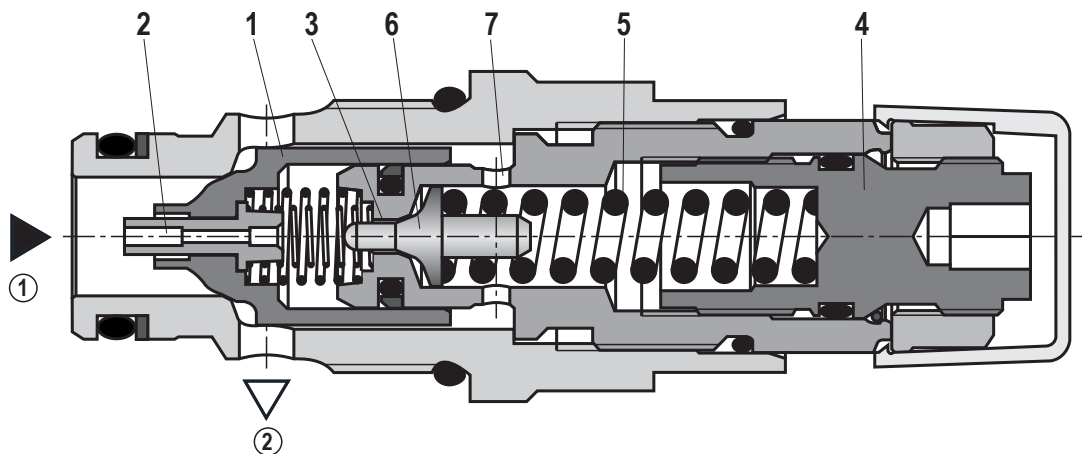

Type MHDBN . K2...

Technical data

(for applications outside these parameters, please consult us!)

general		
Weight	kg	See page 11
Installation position		Any
Ambient temperature range	°C	-20 to +80
Storage temperature range	°C	-20 to +80
Surface protection		Without – surface protection has to be ensured by painting the components or the whole assembly (e.g. valve with housing).

hydraulic			
Maximum operating pressure	Main port ① (P)	bar	100; 420
	Main port ② (T)	bar	50
Maximum flow		l/min	See characteristic curves on pages 6 and 10
Hydraulic fluid			See table below
Hydraulic fluid temperature range		°C	-30 to +80 (NBR seal)
			-20 to +80 (FKM seal)
Viscosity range		mm ² /s	10 to 380
Maximum admissible degree of contamination of the hydraulic fluid - cleanliness class according to ISO 4406 (c)			Class 20/18/15 ¹⁾
Load cycles			2 million ²⁾

Hydraulic fluid	Classification	Suitable sealing materials	Standards
Mineral oils	HL, HLP	NBR, FKM	DIN 51524
Bio-degradable	- insoluble in water	NBR, FKM	VDMA 24568
	- soluble in water	FKM	

 **Important information on hydraulic fluids!**

- ▶ For more information and data on the use of other hydraulic fluids, refer to data sheet 90220 or contact us.
- ▶ There may be limitations regarding the technical valve data (temperature, pressure range, life cycle, maintenance intervals, etc.)!

- ▶ The flash point of the hydraulic fluids used must be 40 K higher than the maximum solenoid surface temperature.
- ▶ **Bio-degradable:** When using bio-degradable hydraulic fluids that are also zinc-solvent, zinc may accumulate in the fluid.

- ¹⁾ The cleanliness classes specified for the components must be adhered to in hydraulic systems. Effective filtration prevents faults and at the same time increases the life cycle of the components. For the selection of the filters, see www.boschrexroth.com/filter. We recommend using a filter with a minimum retention rate of $\beta_{10} \geq 75$.
- ²⁾ Rexroth standard test condition (HLP46; $\vartheta_{oil} = 40 \text{ °C} \pm 5 \text{ °C}$).

 **Attention!**

For operating conditions with an operating pressure of < 30 bar and a flow of < 30 l/min, valves of another design are to be selected from our valve program. The maximum operating pressure is added up from the set pressure and the counter pressure!

 **Notice!**

- The technical data was determined at a viscosity of $v = 41 \text{ mm}^2/\text{s}$ (HLP46; $\vartheta_{oil} = 40 \text{ °C}$).
- The following documentation must be observed: 64020-B1 Hydraulic valves for mobile applications.
- Minimum cracking pressure see characteristic curves pages 6 to 10.
- When exchanging screw-in cartridge valves, ensure that the correct tightening torque is used!

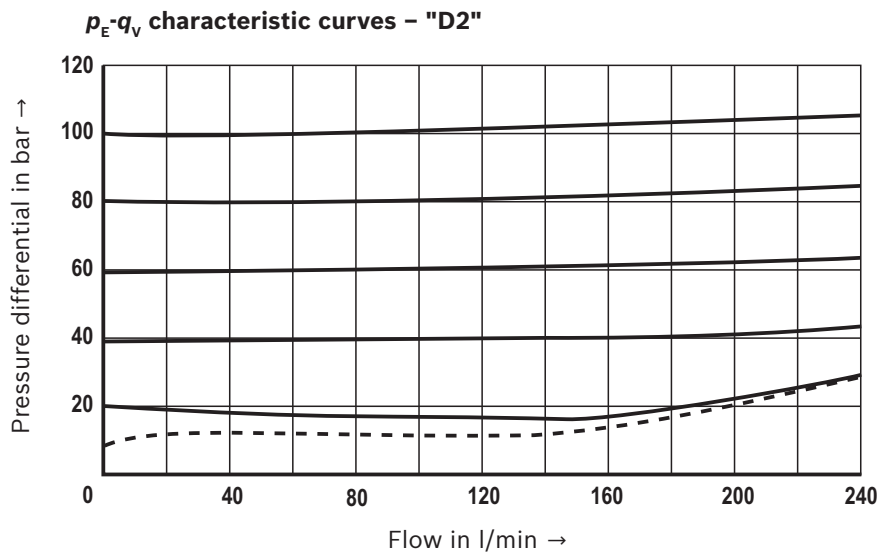
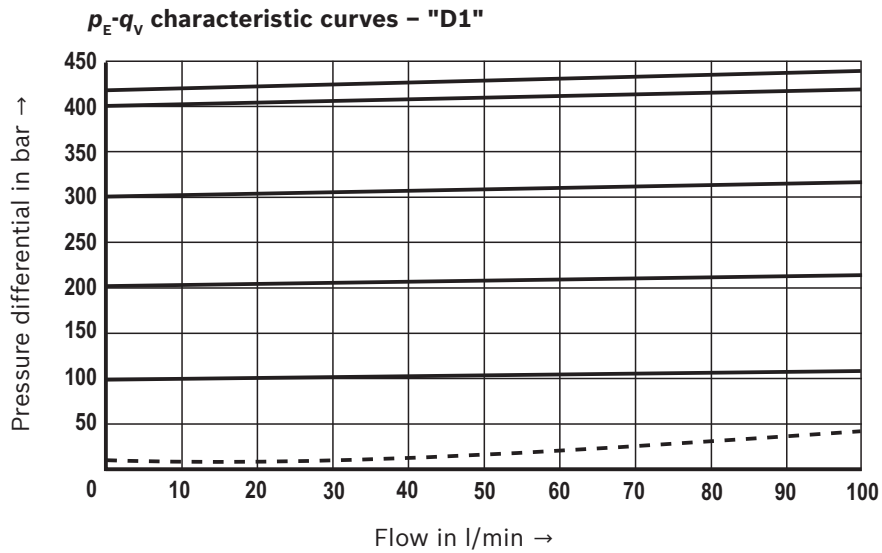
Characteristic curves(measured with HLP46, $\vartheta_{oil} = 40 \pm 5 \text{ } ^\circ\text{C}$)**Notice!**

- The characteristic curves apply for an output pressure $p_T = 0 \text{ bar}$ over the entire flow range and without housing resistance.
- They refer to the specified nominal values of the pressure ratings (100, 420).
- Below the nominal pressure, the characteristic curves become increasingly steeper.

Performance limit

Characteristic curves

(measured with HLP46, $\vartheta_{oil} = 40 \pm 5 \text{ }^\circ\text{C}$)

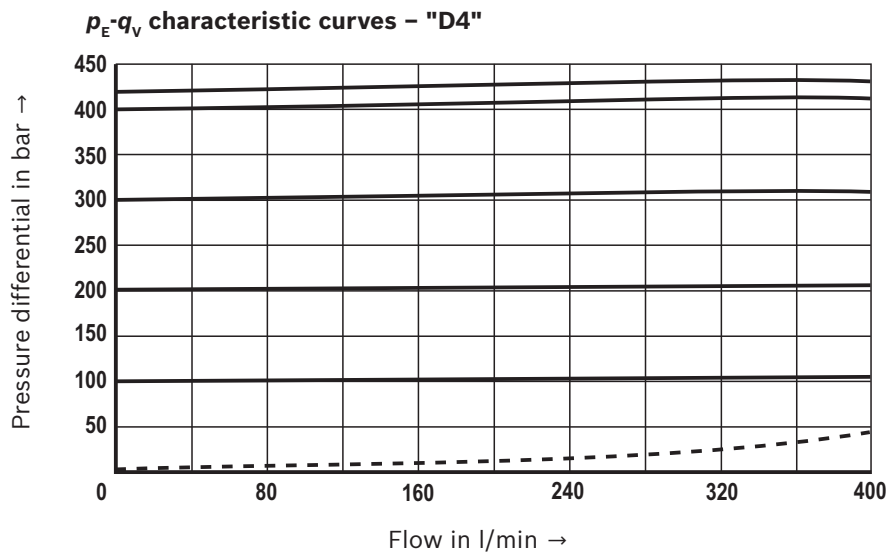
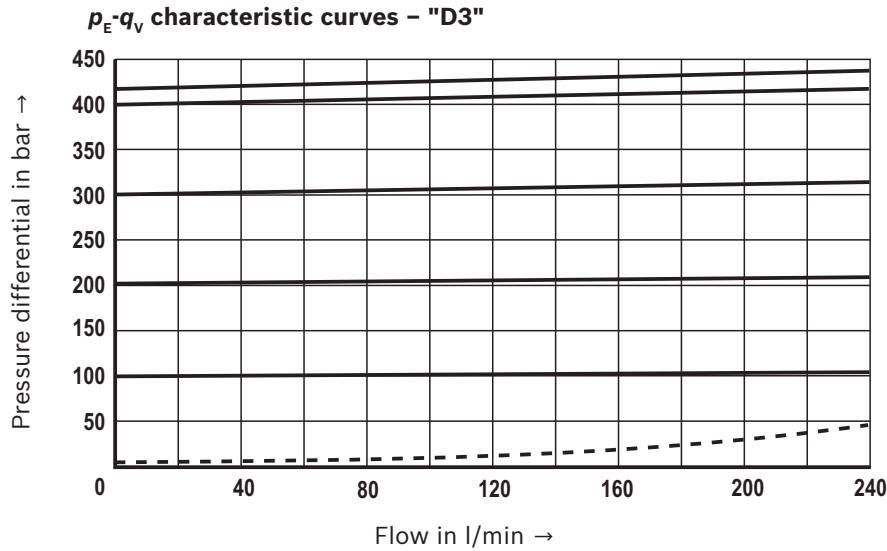

Notice!

- The characteristic curves apply for an output pressure $p_T = 0 \text{ bar}$ over the entire flow range and without housing resistance.
- They refer to the specified nominal values of the pressure ratings (100, 420).
- Below the nominal pressure, the characteristic curves become increasingly steeper.

Performance limit

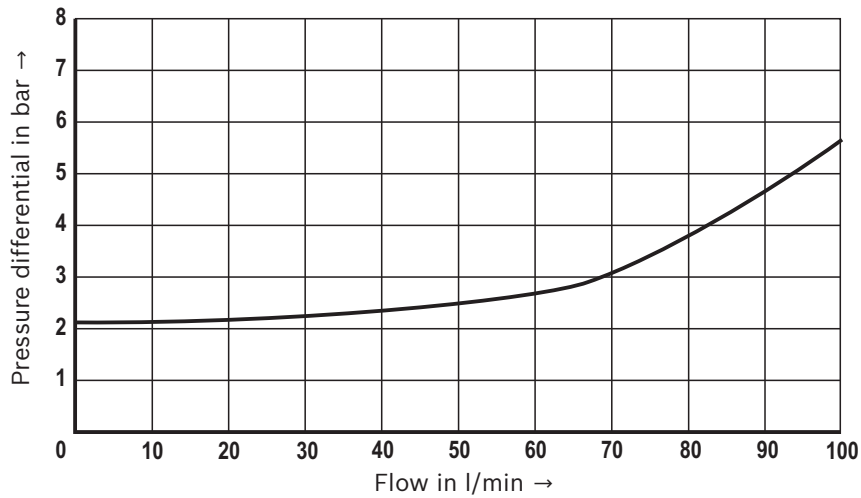
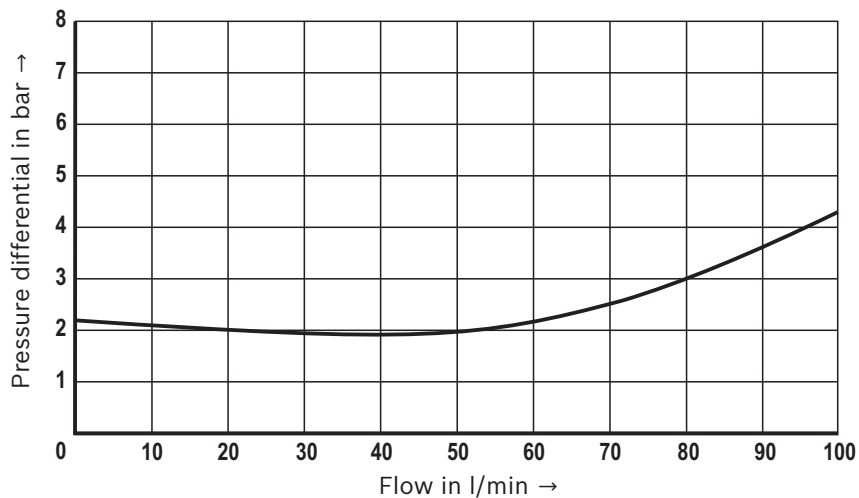
Characteristic curves(measured with HLP46, $\vartheta_{oil} = 40 \pm 5 \text{ }^\circ\text{C}$) **Δp - q_v characteristic curves - "E1"** **Δp - q_v characteristic curves - "E2"****Notice!**

- The characteristic curves apply for an output pressure $p_T = 0$ bar over the entire flow range and without housing resistance.
- They refer to the specified nominal values of the pressure ratings (100, 420).
- Below the nominal pressure, the characteristic curves become increasingly steeper.

Characteristic curves

(measured with HLP46, $\vartheta_{oil} = 40 \pm 5 \text{ }^\circ\text{C}$)

Δp - q_v characteristic curves - "E3"

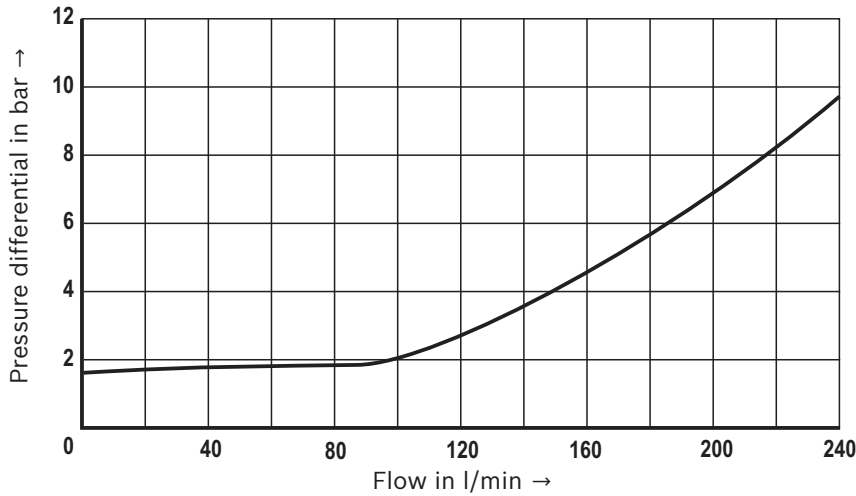

Δp - q_v characteristic curves - "E4"

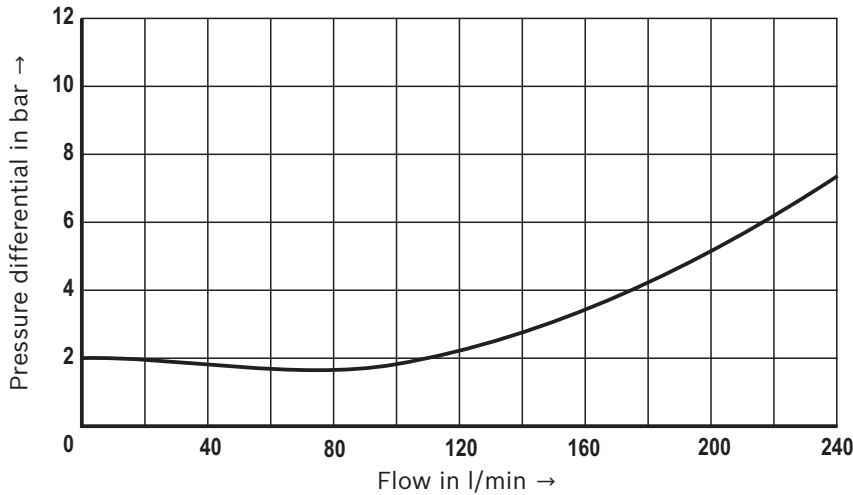

Δp - q_v characteristic curves - "E5"

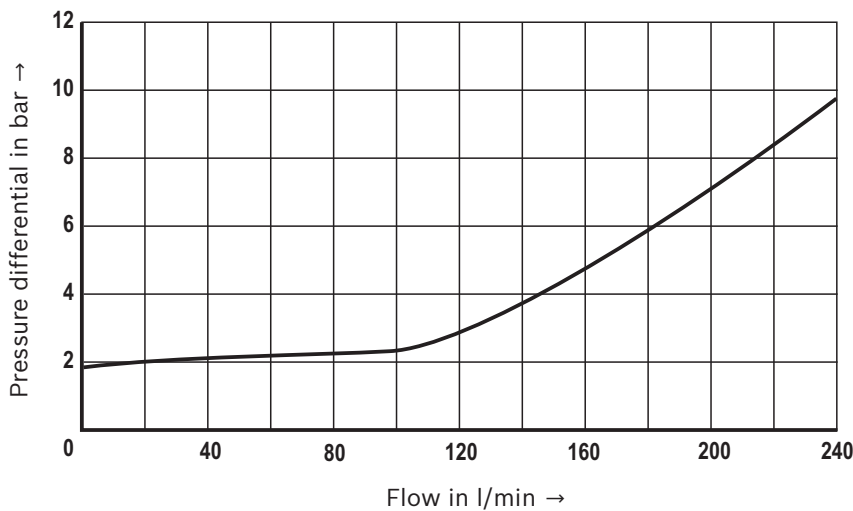

Notice!

- The characteristic curves apply for an output pressure $p_T = 0$ bar over the entire flow range and without housing resistance.
- They refer to the specified nominal values of the pressure ratings (100, 420).
- Below the nominal pressure, the characteristic curves become increasingly steeper.

Characteristic curves

(measured with HLP46, $\vartheta_{oil} = 40 \pm 5 \text{ }^\circ\text{C}$)

Δp - q_v characteristic curves - "E6"

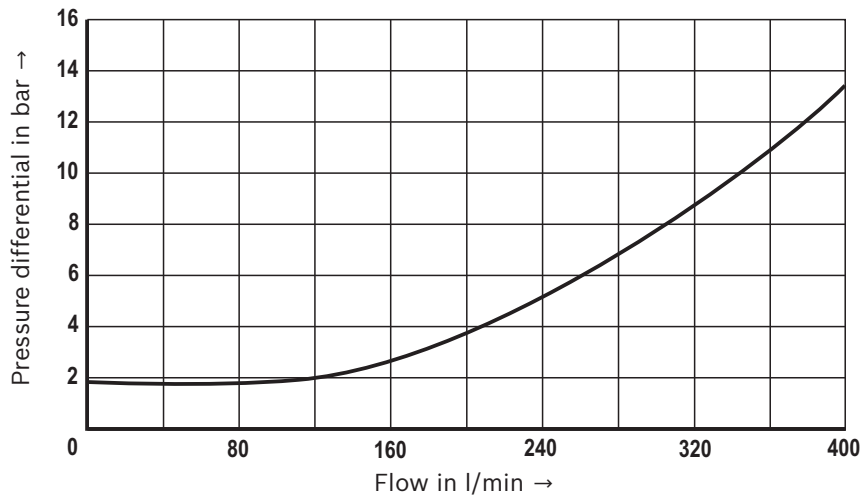

Δp - q_v characteristic curves - "E7"

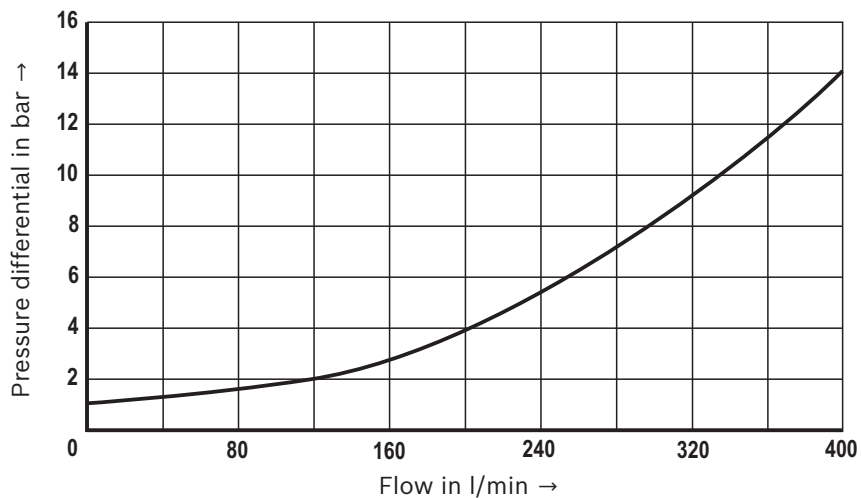

👉 Notice!

- The characteristic curves apply for an output pressure $p_T = 0$ bar over the entire flow range and without housing resistance.
- They refer to the specified nominal values of the pressure ratings (100, 420).
- Below the nominal pressure, the characteristic curves become increasingly steeper.

Unit dimensions
(dimensions in mm)

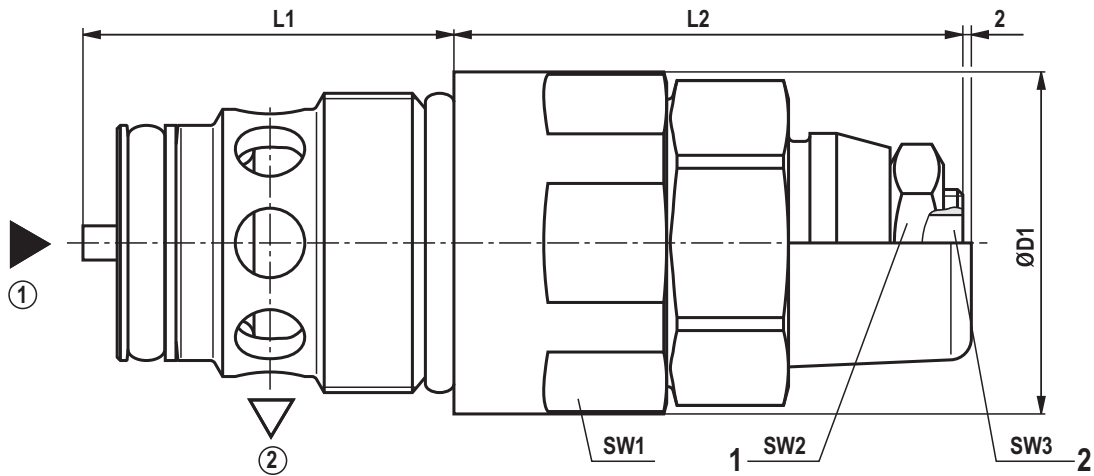

Type	ØD1	L1	L2	Wrench size			Tightening torque in Nm ¹⁾		Weight in kg
				SW1	SW2	SW3	SW1	SW2	
MHDBN 16 K2-3X/...VFB	27.3	24.3	45.0	24	16	5	90	15	0.18
MHDBN 22 K2-3X/...VFC	32.0	34.7	46.4	30	16	5	100	15	0.28
MHDBN 32 K2-3X/...VFK	37.0	40.9	46.1	34	16	5	150	15	0.40

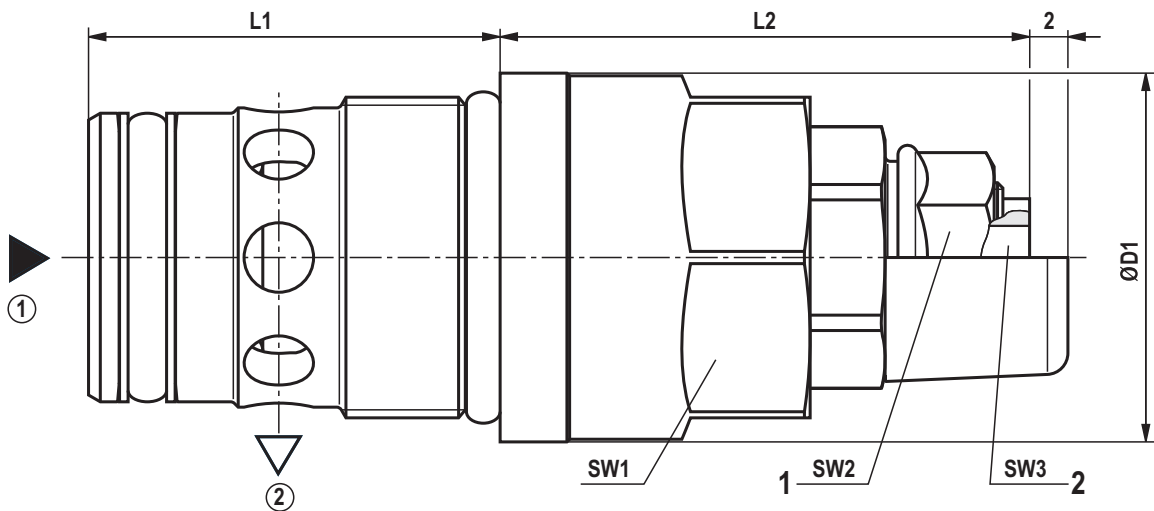

Type	ØD1	L1	L2	Wrench size			Tightening torque in Nm ¹⁾		Weight in kg
				SW1	SW2	SW3	SW1	SW2	
MHDBN 16 K2-3X/...VFH	29.0	35.0	46.8	24	17	5	100	20,	0.21
MHDBN 22 K2-3X/...VVG	34.5	38.5	49.2	30	17	5	100	20	0.25
MHDBN 32 K2-3X/...VLM	41.0	47.4	46.0	36	17	5	150	20	0.45

¹⁾ Friction coefficients, tightening torques, and preload forces interact with each other. The friction coefficients are influenced by the surface microstructure, material pairing, etc. Thus, we recommend checking the mounting characteristics with genuine parts and under boundary conditions.

① = Main port 1 (P)
② = Main port 2 (T)

1 Lock nut
2 Internal hexagon

Mounting cavity (dimensions in mm)

Version "FB" (M24x1)
(drawing no. R901063585)

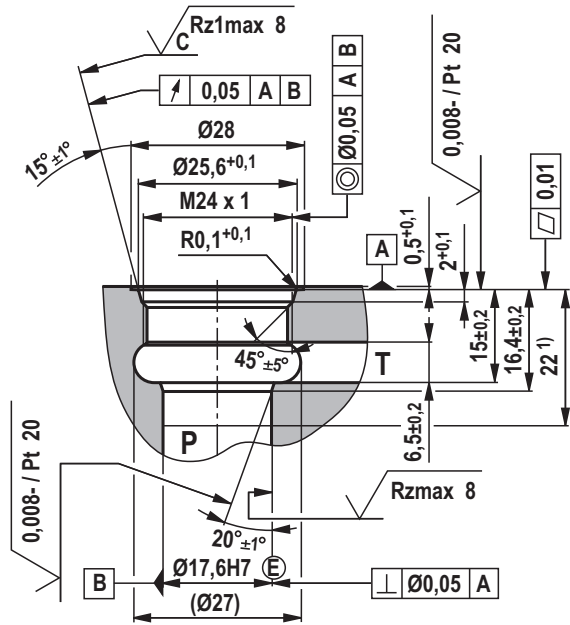

Version "FH" (M24x1.5)
(drawing no. R901148102)

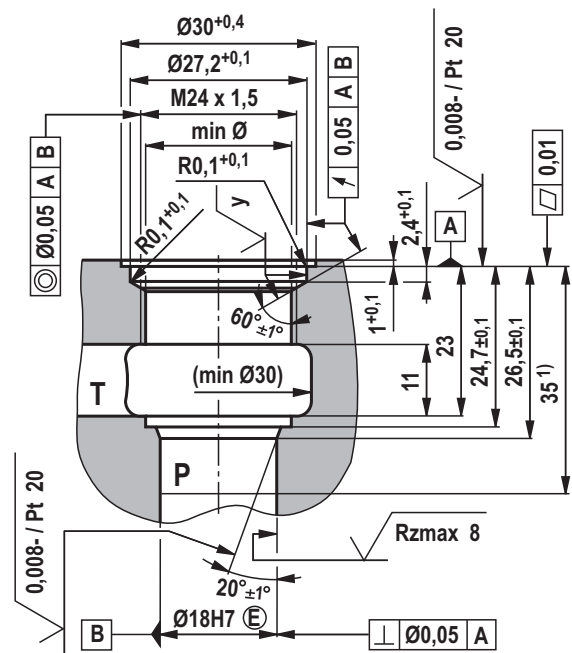

Version "FC" (M28x1)
(drawing no. RA50151421)

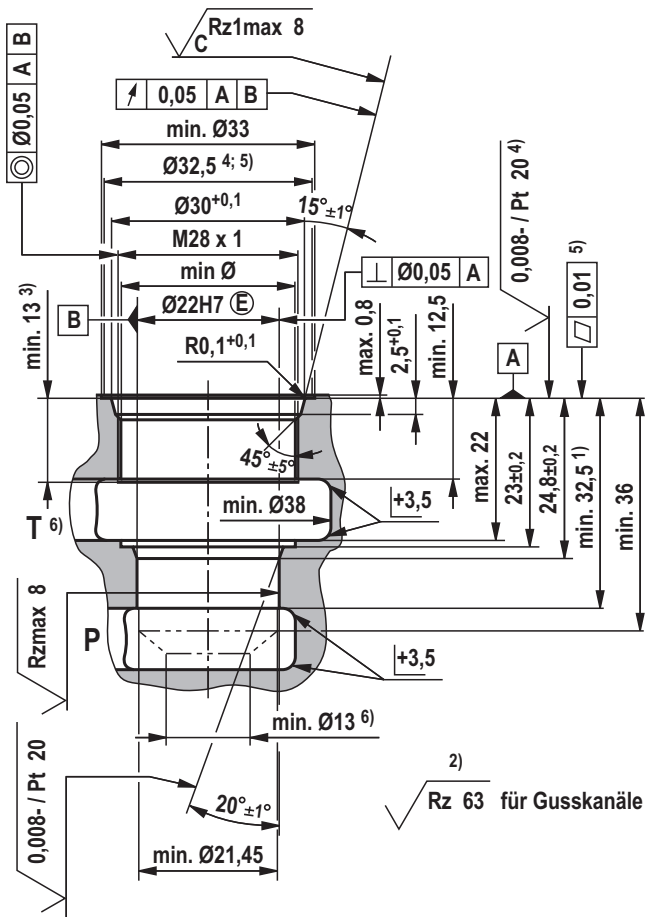

$$\sqrt{y} = \sqrt{C} \sqrt{0,008 - / Pt 10}$$

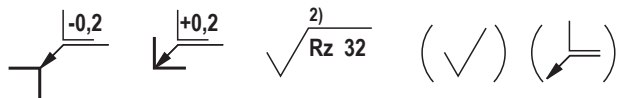

- 1) Depth of fit
 - 2) Visual inspection
 - 3) Thread depth
 - 4) Roughness up to $\phi 32.5$ required
 - 5) Levelness up to $\phi 32.5$ required
 - 6) Required opening cross-section for pumps (P) and tank port (T) > 132 mm²
- All seal ring insertion faces are rounded and free of burrs

Standards:

Workpiece edges	ISO 13715
Form and position tolerance	ISO 1101
General tolerances for metal-cutting procedures	ISO 2768 (mK)
Tolerance	ISO 8015
Surface condition	ISO 1302

Mounting cavity
(dimensions in mm)

Version "LG" (M30x1.5)
(drawing no. R901110408)

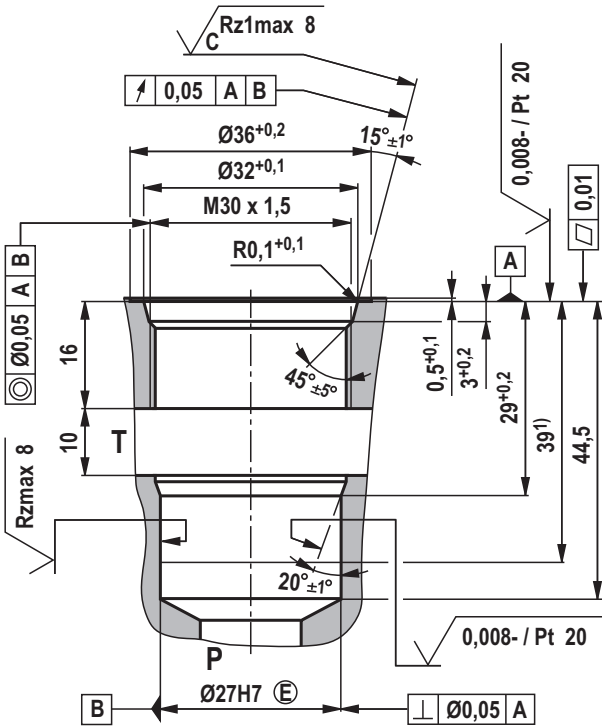

Version "FK" (M33x1)
(drawing no. R901148145)

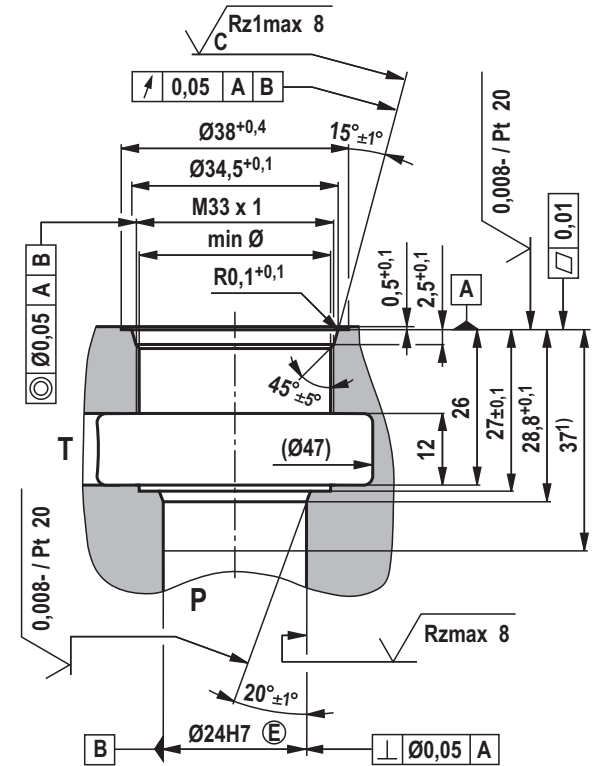

Version "LM" (M36x1.5)
(drawing no. R901148162)

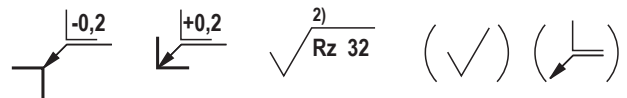
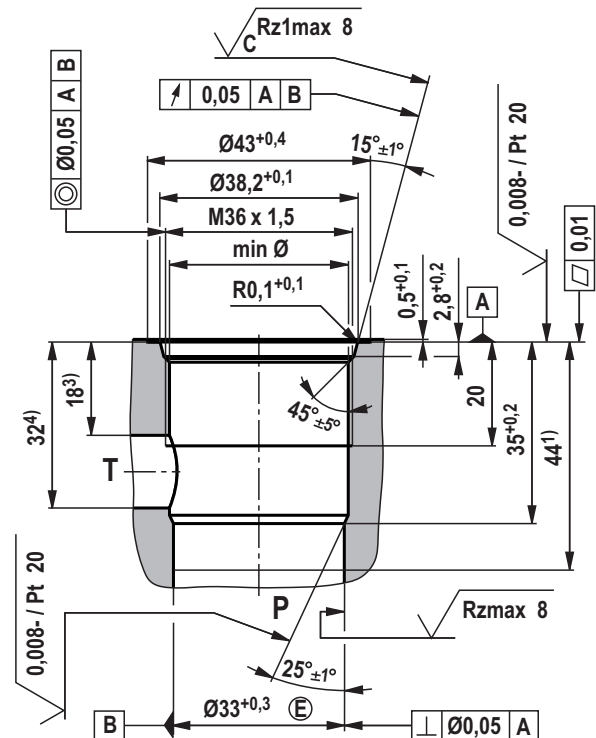

1) Depth of fit
2) Visual inspection
All seal ring insertion faces are rounded and free of burrs

Standards:

Workpiece edges	ISO 13715
Form and position tolerance	ISO 1101
General tolerances for metal-cutting procedures	ISO 2768 (mK)
Tolerance	ISO 8015
Surface condition	ISO 1302

Available individual components

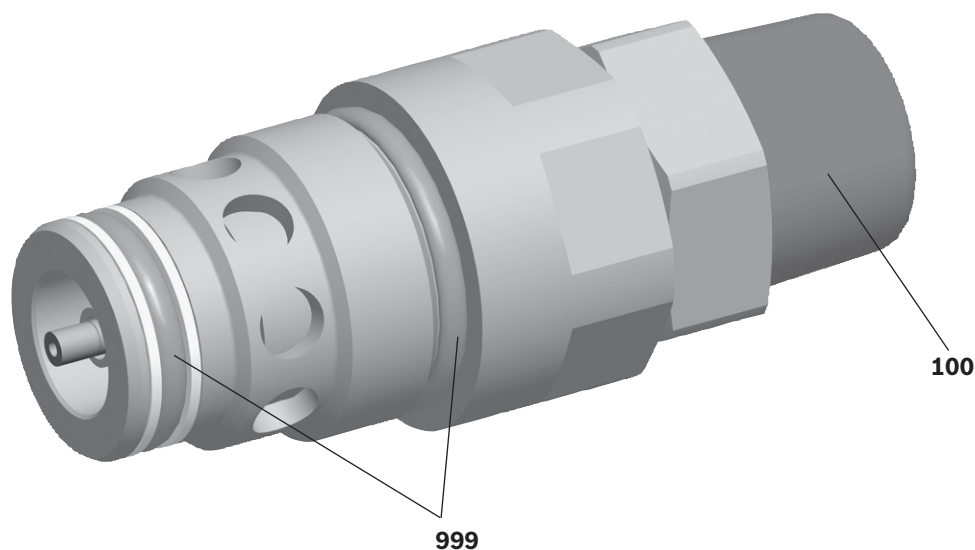

Item	Denomination	Seal material	Material no.
100	Protective cap, separately available	–	R900168151
999	Valve seal kit for mounting cavity "FB"	FKM	R961003378
999	Valve seal kit for mounting cavity "FH"	FKM	R961003387
999	Valve seal kit for mounting cavity "FC"	FKM	R961003380
999	Valve seal kit for mounting cavity "LG"	FKM	R961003397
999	Valve seal kit for mounting cavity "FK"	FKM	R961003389
999	Valve seal kit for mounting cavity "LM"	FKM	R961003398

Seal kits with other seals upon request.

Bosch Rexroth AG
 Hydraulics
 Zum Eisengießer 1
 97816 Lohr am Main, Germany
 Phone +49 (0) 93 52/ 18-0
 documentation@boschrexroth.de
 www.boschrexroth.de

© This document, as well as the data, specifications and other information set forth in it, are the exclusive property of Bosch Rexroth AG. It may not be reproduced or given to third parties without its consent.
 The data specified above only serve to describe the product. No statements concerning a certain condition or suitability for a certain application can be derived from our information. The information given does not release the user from the obligation of own judgment and verification.
 It must be remembered that our products are subject to a natural process of wear and aging.

Notes

Bosch Rexroth AG
Hydraulics
Zum Eisengießer 1
97816 Lohr am Main, Germany
Phone +49 (0) 93 52/18-0
documentation@boschrexroth.de
www.boschrexroth.de

© This document, as well as the data, specifications and other information set forth in it, are the exclusive property of Bosch Rexroth AG. It may not be reproduced or given to third parties without its consent.
The data specified above only serve to describe the product. No statements concerning a certain condition or suitability for a certain application can be derived from our information. The information given does not release the user from the obligation of own judgment and verification.
It must be remembered that our products are subject to a natural process of wear and aging.

Notes

Bosch Rexroth AG
Hydraulics
Zum Eisengießer 1
97816 Lohr am Main, Germany
Phone +49 (0) 93 52/ 18-0
documentation@boschrexroth.de
www.boschrexroth.de

© This document, as well as the data, specifications and other information set forth in it, are the exclusive property of Bosch Rexroth AG. It may not be reproduced or given to third parties without its consent.
The data specified above only serve to describe the product. No statements concerning a certain condition or suitability for a certain application can be derived from our information. The information given does not release the user from the obligation of own judgment and verification.
It must be remembered that our products are subject to a natural process of wear and aging.