

Dimensions

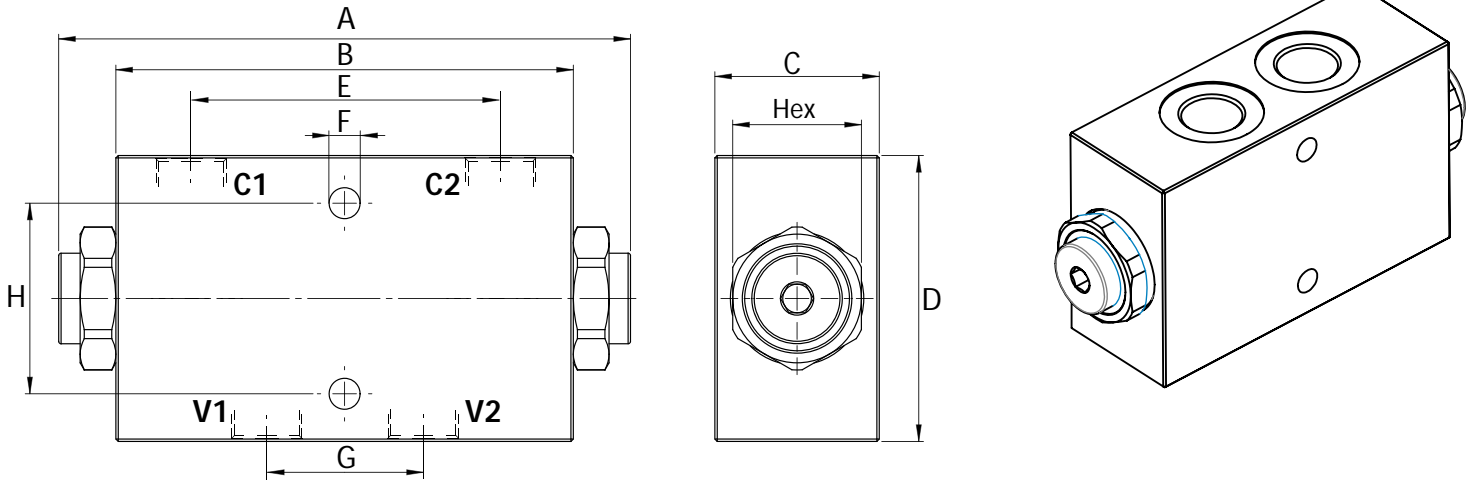

Size	C1-C2 V1-V2 BSP	A	B	C	D	E	F	G	H	Hex	Weight kg
01	1/4	113	90	25	50	62	6,5	32	40	22	0,79
15	3/8	113	90	25	50	62	6,5	32	40	22	0,76
02	3/8	113	96	35	60	62	6,5	32	40	27	0,62
25	1/2	113	96	35	60	62	6,5	32	40	27	0,60
03	1/2	140	110	35	70	69	8,5	34	40	30	0,89
04	3/4	220	165	50	90	105	8,5	50	60	41	2,550

Hydraulic Symbol

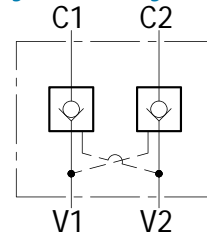

Curves

V1 → C1
V2 → C2

C1 → V1
C2 → V2

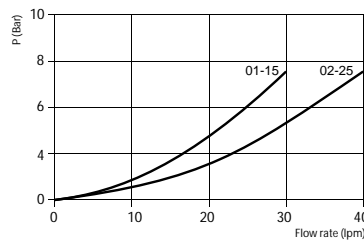
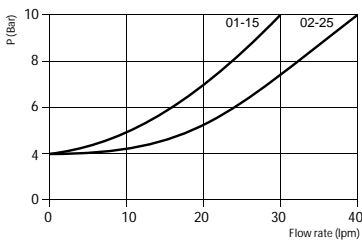

Features

Size	01	15	02	25	03	04
Max Pressure (bar)	260	260	260	260	260	260
Max Flow (lpm)	20	20	35	35	60	100
Pilot Ratio	1:4	1:4	1:7	1:7	1:3,4	1:4
Cracking Pressure (bar)	4	4	4	4	3	8

Materials: Aluminium manifold, hardened steel inner parts.

Ordering Code

LVDL - -

	Size BSP
01	1/4
15	3/8
02	3/8
25	1/2
03	1/2
04	3/4

Ordering Code Example: LVDL15 = 3/8 BSP, 20 lpm.