

Solenoid Operated Directional Control

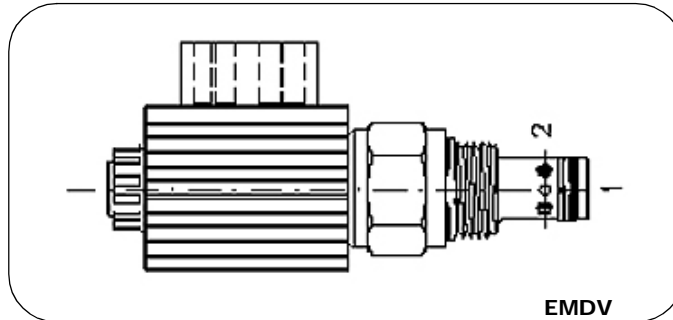
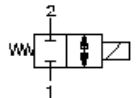
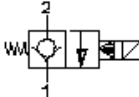
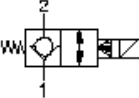
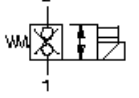
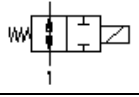
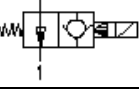
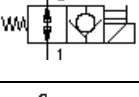
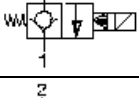
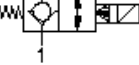

2 way, 2 position, single coil.

CIRCUIT	SOLENOID OPERATED - Directional Control				
	MODEL	TYPE	FLOW	CAVITY	PRICE
	EMDV-08-N-C6-0-XXXX EMDV-10-N-C1-0-XXXX EMDV-12-N-C1-0-XXXX	SPOOL	19 38 68	0820 1020 1220	\$POA \$POA \$POA
	EMDV-08-N-C7-0-XXXX EMDV-10-N-C2-0-XXXX EMDV-12-N-C2-0-XXXX EMDV-16-N-C2-0-XXXX	POPPET	38 68 136 190	0820 1020 1220 1620	\$POA \$POA \$POA \$POA
	EMDV-08-N-C8-0-XXXX EMDV-12-N-C4-0-XXXX EMDV-16-N-C4-0-XXXX	POPPET	38 136 190	0820 1220 1620	\$POA \$POA \$POA
	EMDV-10-N-C3-0-XXXX	POPPET	23	1020	\$POA
	EMDV-08-N-O6-0-XXXX EMDV-10-N-O1-0-XXXX EMDV-12-N-O1-0-XXXX	SPOOL	19 30 68	0820 1020 1220	\$POA \$POA \$POA
	EMDV-10-N-O2-0-XXXX EMDV-12-N-O2-0-XXXX EMDV-16-N-O2-0-XXXX	POPPET	68 136 190	1020 1220 1620	\$POA \$POA \$POA
	EMDV-12-N-O4-0-XXXX EMDV-16-N-O4-0-XXXX	POPPET	136 190	12201 1620	\$POA \$POA
	EMDV-08-N-O7-0-XXXX	POPPET	38	0820	\$POA
	EMDV-08-N-O8-0-XXXX	POPPET	38	0820	\$POA

NB: Replace XXXX in the part number with the voltage ie: 12DC