

Duplex Filter Pi 370

Nominal pressure 200/210/250/315 bar (2900/3040/3620/4570 psi), nominal size up to 450

1. Features

High performance filters for modern hydraulic systems

- Modular system
- Compact design
- Minimal pressure drop through optimal flow design
- Visual/electrical/electronic maintenance indicator
- Threaded connections
- Change over valve on upstream side
- Ergonomic switch-over handle with safety lock and pressure compensation
- User-optimized one-hand-operation
- Equipped with highly efficient glass-fibre PS filter elements
- Beta rated elements according to ISO 16889 multipass test
- Elements with high differential pressure stability and dirt holding capacity
- NPT- and SAE-connections on request
- Worldwide distribution



2. Flow rate/pressure drop curve complete filter

190 mm²/s
33 mm²/s

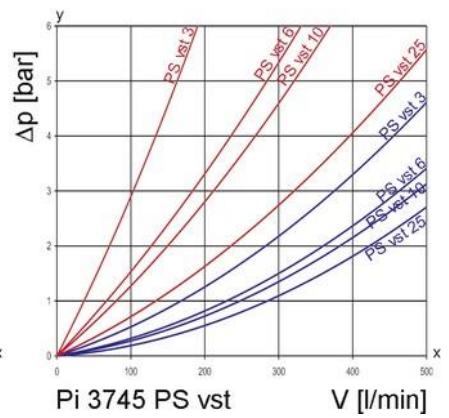
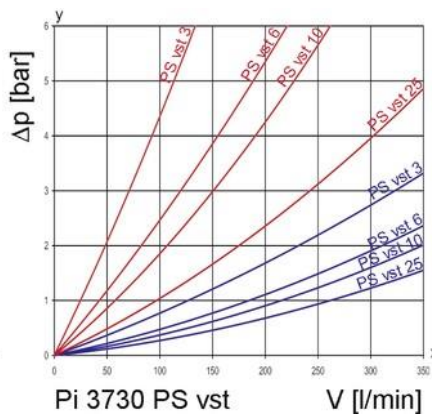
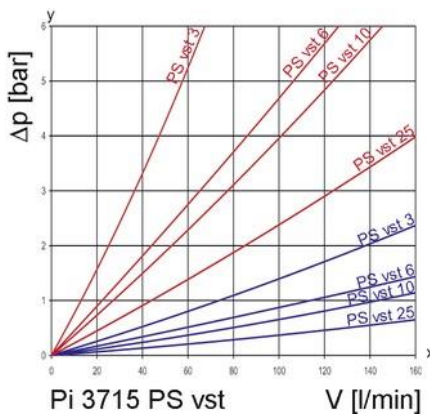
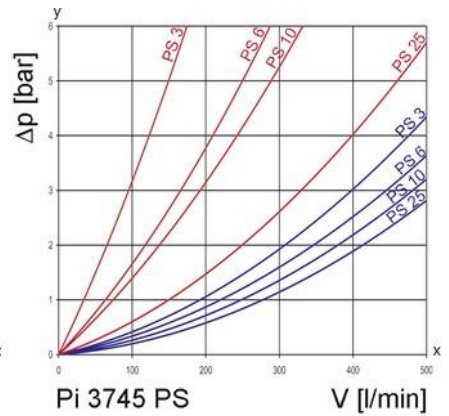
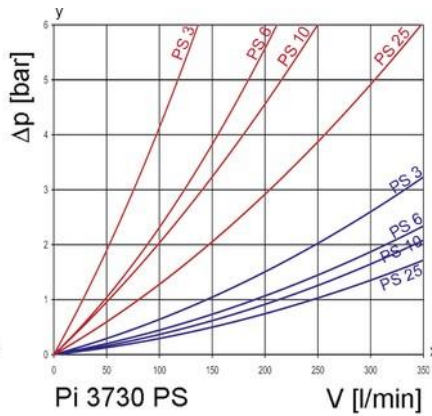
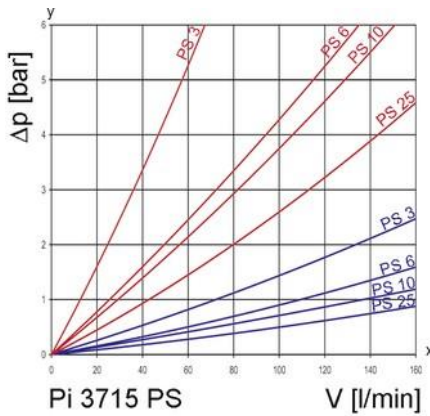
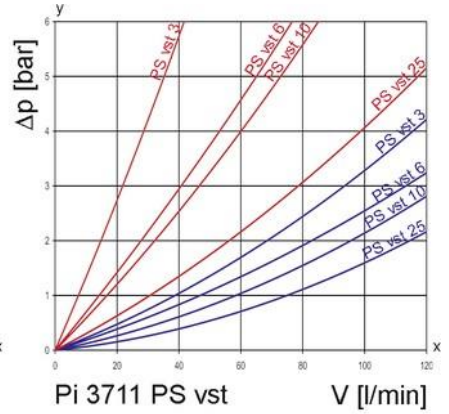
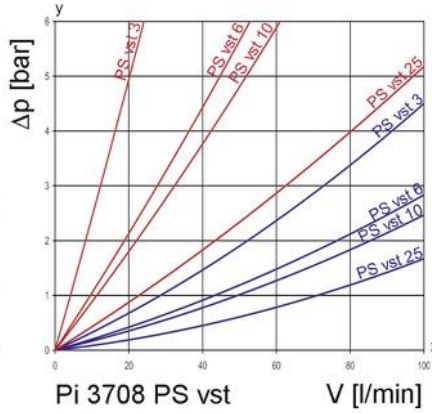
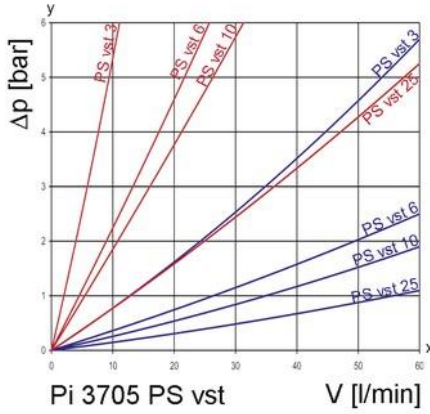
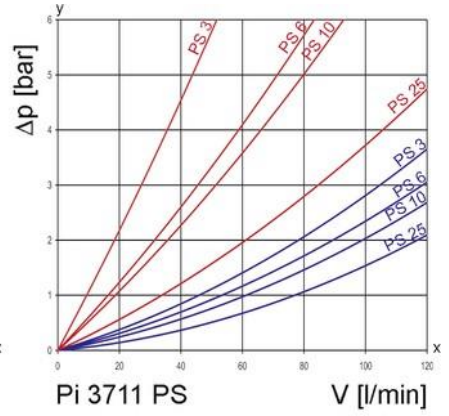
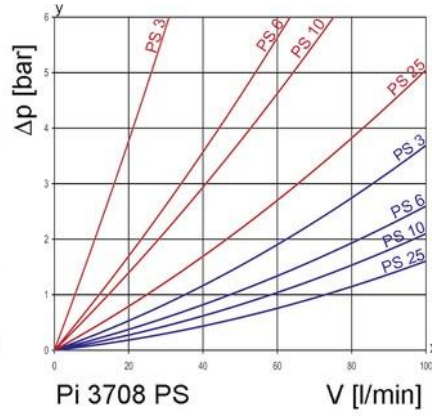
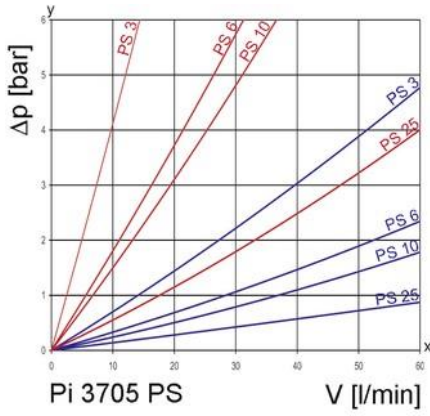

y = differential pressure Δp [bar]
x = flow rate V [l/min]

3. Separation grade characteristics

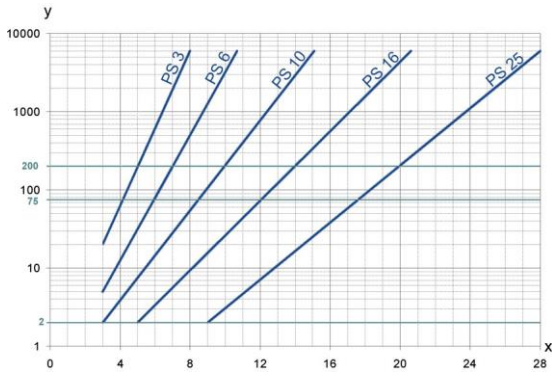

y = beta-value
x = particle size [μm]

determined by multipass tests (ISO 16889)
calibration according to ISO 11171 (NIST)

5. Quality assurance

Filtration Group filters and filter elements are produced according to the following international standards:

| Norm | Designation |
|--------------|---|
| DIN ISO 2941 | Hydraulic fluid power filter elements; verification of collapse/burst pressure |
| DIN ISO 2942 | Hydraulic fluid power filter elements; verification of fabrication integrity |
| DIN ISO 2943 | Hydraulic fluid power filter elements; verification of material compatibility with fluids |
| DIN ISO 3723 | Hydraulic fluid power filter elements; method for end load test |
| DIN ISO 3724 | Hydraulic fluid power filter elements; verification of flow fatigue characteristics |
| ISO 3968 | Hydraulic fluid power filter; evaluation of pressure drop versus flow characteristics |
| ISO 10771.1 | Fatigue pressure testing of metal containing envelopes in hydraulic fluid applications |
| ISO 16889 | Hydraulic fluid power filters; multipass method for evaluation filtration performance of a filter element |

6. Symbols

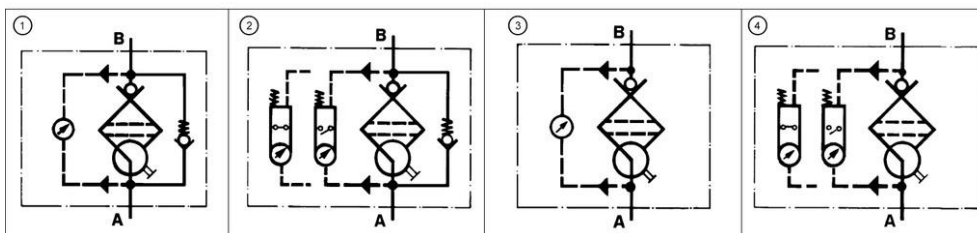

4. Filter performance data

tested according to ISO 16889 (multipass test)

PS elements with
max. Δp 20 bar

PS 3 $\beta_{5(C)} \geq 200$
PS 6 $\beta_{7(C)} \geq 200$
PS 10 $\beta_{10(C)} \geq 200$
PS 25 $\beta_{20(C)} \geq 200$

values guaranteed up to
10 bar differential pressure

PS vst elements with
max. Δp 210 bar

PS vst 3 $\beta_{5(C)} \geq 200$
PS vst 6 $\beta_{7(C)} \geq 200$
PS vst 10 $\beta_{10(C)} \geq 200$
PS vst 25 $\beta_{20(C)} \geq 200$

values guaranteed up to
20 bar differential pressure

7. Order numbers

Example for ordering filters:

| 1. Filter housing | 2. 2x Filter element |
|--|--|
| V = 80 l/min and electrical maintenance indicator Type: Pi 3708-015 Order number: 77810369 | PS vst 3 Type: Pi 2208 PS vst 3 Order number: 77680200 |

| 7.1 Housing design | | | | | | |
|----------------------------|-----------------|-------------|--|--|----------------------------------|--------------------------------------|
| Nominal size NG [l/min] | Order number | Type | ① with bypass valve and visual indicator | ② with bypass valve and electrical indicator | ③ with visual indicator | ④ with electrical indicator |
| 50 | 77810294 | Pi 3705-012 | | | | |
| | 77810302 | Pi 3705-013 | | | | |
| | 77810310 | Pi 3705-014 | | | | |
| | 77810328 | Pi 3705-015 | | | | |
| 80 | 77810336 | Pi 3708-012 | | | | |
| | 77810344 | Pi 3708-013 | | | | |
| | 77810351 | Pi 3708-014 | | | | |
| | 77810369 | Pi 3708-015 | | | | |
| 110 | 77810377 | Pi 3711-012 | | | | |
| | 77810385 | Pi 3711-013 | | | | |
| | 77810393 | Pi 3711-014 | | | | |
| | 77810401 | Pi 3711-015 | | | | |
| 150 | 77810419 | Pi 3715-012 | | | | |
| | 77810427 | Pi 3715-013 | | | | |
| | 77810435 | Pi 3715-014 | | | | |
| | 77810443 | Pi 3715-015 | | | | |
| 300 | 77810450 | Pi 3730-012 | | | | |
| | 77810468 | Pi 3730-013 | | | | |
| | 77810476 | Pi 3730-014 | | | | |
| | 77810484 | Pi 3730-015 | | | | |
| 450 | 77810492 | Pi 3745-012 | | | | |
| | 77814403 | Pi 3745-013 | | | | |
| | 77814411 | Pi 3745-014 | | | | |
| | 77814429 | Pi 3745-015 | | | | |

When filter with non bypass configuration is selected, the collapse pressure of the element must not be exceeded.

7.2 Filter elements (a wider range of element types is available on request)

| Nominal size NG [l/min] | Order number | Type | Filter material | max. Δp [bar] | Filter surface [cm ²] |
|----------------------------|-----------------|-------------------|-----------------|--------------------------|--------------------------------------|
| 50 | 77680135 | Pi 2105 PS 3 | PS 3 | 20 | 590 |
| | 77943509 | Pi 5105 PS 6 | PS 6 | | 590 |
| | 77680325 | Pi 3105 PS 10 | PS 10 | | 590 |
| | 77680440 | Pi 4105 PS 25 | PS 25 | | 590 |
| | 77680192 | Pi 2205 PS vst 3 | PS vst 3 | 210 | 425 |
| | 77943533 | Pi 5205 PS vst 6 | PS vst 6 | | 425 |
| | 77680382 | Pi 3205 PS vst 10 | PS vst 10 | | 425 |
| | 77680507 | Pi 4205 PS vst 25 | PS vst 25 | | 425 |
| 80 | 77680143 | Pi 2108 PS 3 | PS 3 | 20 | 1150 |
| | 77943517 | Pi 5108 PS 6 | PS 6 | | 1150 |
| | 77680341 | Pi 3108 PS 10 | PS 10 | | 1150 |
| | 77680457 | Pi 4108 PS 25 | PS 25 | | 1150 |
| | 77680200 | Pi 2208 PS vst 3 | PS vst 3 | 210 | 850 |
| | 77943541 | Pi 5208 PS vst 6 | PS vst 6 | | 850 |
| | 77681190 | Pi 3208 PS vst 10 | PS vst 10 | | 850 |
| | 77680515 | Pi 4208 PS vst 25 | PS vst 25 | | 850 |
| 110 | 77680150 | Pi 2111 PS 3 | PS 3 | 20 | 1700 |
| | 77943525 | Pi 5111 PS 6 | PS 6 | | 1700 |
| | 77680333 | Pi 3111 PS 10 | PS 10 | | 1700 |
| | 77680465 | Pi 4111 PS 25 | PS 25 | | 1700 |
| | 77680218 | Pi 2211 PS vst 3 | PS vst 3 | 210 | 1275 |
| | 77943558 | Pi 5211 PS vst 6 | PS vst 6 | | 1275 |
| | 77680390 | Pi 3211 PS vst 10 | PS vst 10 | | 1275 |
| | 77680523 | Pi 4211 PS vst 25 | PS vst 25 | | 1275 |
| 150 | 77680168 | Pi 2115 PS 3 | PS 3 | 20 | 2425 |
| | 77955099 | Pi 5115 PS 6 | PS 6 | | 2425 |
| | 77680358 | Pi 3115 PS 10 | PS 10 | | 2425 |
| | 77680473 | Pi 4115 PS 25 | PS 25 | | 2425 |
| | 77680226 | Pi 2215 PS vst 3 | PS vst 3 | 210 | 2010 |
| | 77955123 | Pi 5215 PS vst 6 | PS vst 6 | | 2010 |
| | 77680408 | Pi 3215 PS vst 10 | PS vst 10 | | 2010 |
| | 77680531 | Pi 4215 PS vst 25 | PS vst 25 | | 2010 |
| 300 | 77680176 | Pi 2130 PS 3 | PS 3 | 20 | 4620 |
| | 77955107 | Pi 5130 PS 6 | PS 6 | | 4620 |
| | 77680366 | Pi 3130 PS 10 | PS 10 | | 4620 |
| | 77680481 | Pi 4130 PS 25 | PS 25 | | 4620 |
| | 77680234 | Pi 2230 PS vst 3 | PS vst 3 | 210 | 3800 |
| | 77955131 | Pi 5230 PS vst 6 | PS vst 6 | | 3800 |
| | 77680416 | Pi 3230 PS vst 10 | PS vst 10 | | 3800 |
| | 77680549 | Pi 4230 PS vst 25 | PS vst 25 | | 3800 |
| 450 | 77680184 | Pi 2145 PS 3 | PS 3 | 20 | 6865 |
| | 77955115 | Pi 5145 PS 6 | PS 6 | | 6865 |
| | 77680374 | Pi 3145 PS 10 | PS 10 | | 6865 |
| | 77680499 | Pi 4145 PS 25 | PS 25 | | 6865 |
| | 77680242 | Pi 2245 PS vst 3 | PS vst 3 | 210 | 5600 |
| | 77955149 | Pi 5245 PS vst 6 | PS vst 6 | | 5600 |
| | 77680424 | Pi 3245 PS vst 10 | PS vst 10 | | 5600 |
| | 77680556 | Pi 4245 PS vst 25 | PS vst 25 | | 5600 |

8. Technical specifications

| | |
|---|--|
| Design: | line mounting filter |
| Operating pressure: | |
| Pi 3705 - Pi 3711 | 10 ⁷ load changes 250 bar (3620 psi) |
| | 10 ⁶ load changes 315 bar (4570 psi) |
| Pi 3715 - Pi 3745 | 2x 10 ⁶ load changes 210 bar (3040 psi) |
| Test pressure: | |
| Pi 3705 - Pi 3711 | 450 bar (6520 psi) |
| Pi 3715 - Pi 3745 | 300 bar (4350 psi) |
| Pi 3705 - Pi 3745 when use on ships operating/test pressure | 200/260 bar (2900/3770 psi) |
| Temperature range: | -10 °C to +120 °C (other temperature ranges on request) |
| Bypass opening pressure: | Δp 7 bar \pm 10 % |
| Filter head material: | GGG |
| Filter bowl material: | St |
| Sealing material: | NBR/PTFE |
| Activating pressure of optical/electrical differential pressure indicator | Δp 5 bar \pm 10 % |
| Electrical data of contamination indicator: | |
| Maximum voltage: | 250 V AC/200 V DC |
| Maximum current on contact: | 1 A |
| Inrush current: | 70 W |
| Type of protection: | IP 65 when inserted and secured |
| Contact: | bistable |
| Cable connection: | M20x1.5 |

The switching function can be changed by turning the electric upper part by 180° (normally closed contact or normally open contact). The state on delivery is a normally closed contact. The use of quenching circuits must be checked in the case of inductivity in the DC current circuit. The contamination indicator data sheet contains further information and additional contamination indicator versions.

We draw attention to the fact that all values indicated are average values which do not always occur in specific cases of application. Our products are continually being further developed. Values, dimensions and weights can change as a result of this. Our specialized department will be pleased to offer you advice.

We recommend you to contact us concerning applications of our filters in areas governed by the EU Directive 94/9 EC (ATEX 95). The standard version can be used for liquids based on mineral oil (corresponding to the fluids in Group 2 of Directive 97/23 EC Article 9). If you consider to use other fluids please contact us for additional support.

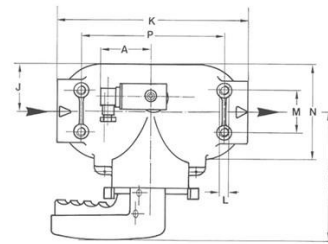
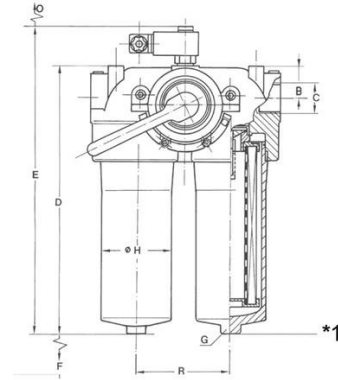

*1 Pi 3730-Pi 3745 with drain screw G ¼ DIN 910

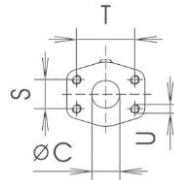

9. Dimensions

All dimensions except "C" in mm.

| Type | A | B | C* | D | E | F | Weight [kg] |
|---------|----|----|-----|-----|-----|-----|-------------|
| Pi 3705 | 78 | 38 | G1 | 219 | 271 | 80 | 11.0 |
| Pi 3708 | 78 | 38 | G1 | 294 | 346 | 80 | 12.0 |
| Pi 3711 | 78 | 38 | G1 | 370 | 422 | 80 | 15.0 |
| Pi 3715 | 78 | 50 | G1½ | 302 | 354 | 110 | 31.5 |
| Pi 3730 | 78 | 50 | G1½ | 427 | 479 | 110 | 37.0 |
| Pi 3745 | 78 | 50 | G1½ | 543 | 595 | 110 | 41.5 |

* SAE flange connection on request.

Subject to technical alteration without prior notice.

| Type | G SW | H | I | J | K | L | M | N | O | P | R | S | T | U | Weight [kg] |
|---------|------|-----|-----|----|-----|--------|----|-----|----|-----|-----|------|-------|--------|-------------|
| Pi 3705 | 27 | 65 | 144 | 45 | 182 | M8x15 | 55 | 90 | 45 | 100 | 86 | - | - | - | 11.0 |
| Pi 3708 | 27 | 65 | 144 | 45 | 182 | M8x15 | 55 | 90 | 45 | 100 | 86 | - | - | - | 12.0 |
| Pi 3711 | 27 | 65 | 144 | 45 | 182 | M8x15 | 55 | 90 | 45 | 100 | 86 | - | - | - | 15.0 |
| Pi 3715 | 30 | 110 | 175 | 70 | 280 | M12x18 | 62 | 140 | 45 | 210 | 136 | - | - | - | 31.5 |
| Pi 3730 | 30 | 110 | 175 | 70 | 280 | M12x18 | 62 | 140 | 45 | 210 | 136 | - | - | - | 37.0 |
| Pi 3745 | 30 | 110 | 175 | 70 | 280 | M12x18 | 62 | 140 | 45 | 210 | 136 | 35.7 | 69.85 | M12x20 | 41.5 |

10. Installation, operating and maintenance instructions

10.1 Filter installation

When installing filter make sure that sufficient space is available to remove filter element and filter housing.

Preferably the filter should be installed with the filter housing pointing downwards.

The maintenance indicator must be visible.

10.2 Connecting the electrical maintenance indicator

The electrical indicator is connected via a 2-pole appliance plug according to DIN EN 175301-803 with poles marked 1 and 2. The electrical section can be inverted to change from normally open to normally closed position or vice versa.

10.3 When should the filter element be replaced?

1. Filters equipped with visual and electrical maintenance indicator:
During cold starts, the indicator may give a warning signal. Press the red button of the visual indicator once again only after operating temperature has been reached. If the red button immediately pops up again and/or the electrical signal has not switched off after reaching operating temperature the filter element must be replaced after the end of the shift.
2. Please always ensure that you have original Filtration Group spare elements in stock: Disposable elements (PS) cannot be cleaned.

10.4 Element replacement

Note: Elements may only be replaced by people who are familiar with the function of the filter. When replacing elements, appropriate safety clothing (protective goggles, gloves, safety shoes) must be worn.

Note: The maintenance indicator monitors the filter side in operation, which is identified by the position of the switching lever catch. The change-over transfer valve must be switched prior filter servicing. Now the signal of the maintenance indicators cancelled and the red button can be repressed again.

1. Operate and hold pressure equalizing lever located behind switching lever. Pull catch knob and swivel switching lever. Engage the catch on the clear filter side. Place through or drip pan underneath to collect leaving oil.
2. Loosen vent screw of the filter side not in use by 2-3 turns; max. until contact is made with the safety stop.
3. Unscrew filter housing by rotating same counter-clockwise and clean with a suitable medium.
Warning: The shift lever may not, from now until the screwing back in of the filter housing (7.), be activated under any circumstances!
4. Remove filter element with a side-to-side motion.
5. Check O-ring on the filter house for damage. Replace, if necessary.
6. Make sure that the order number on the spare element corresponds to the order number of the filter name-plate.
7. Lightly lubricate the threads of the filter housing and screw into the filter head. Maximum tightening torque for NG 50 to 110 = 60 Nm, for NG 150 to 450 = 100 Nm.
8. To refill the filter chamber, operate only the pressure equalizing lever (leave the switching lever arrested in its catch) long enough for the medium to emerge bubble-free from the vent bore.
9. Tighten vent screw. Check filter for leaks by operating the pressure equalizing lever once again.

11. Spare parts list

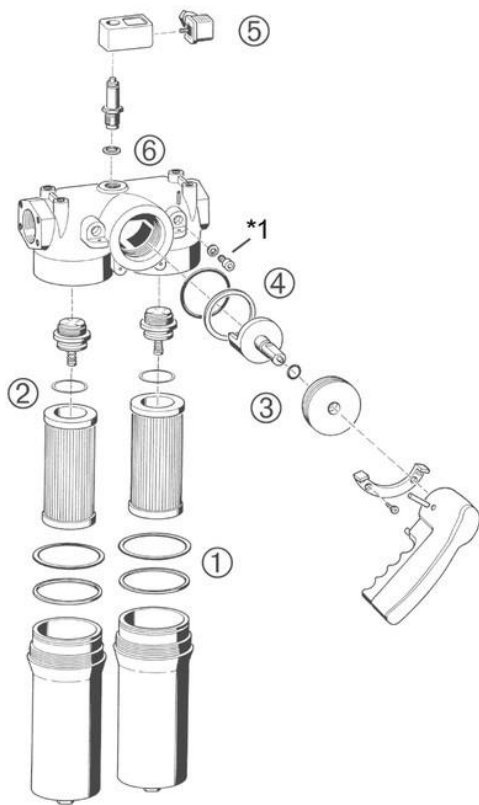

*1 vent screw

| Order numbers for spare parts | | |
|-------------------------------|------------------------------------|---------------|
| Position | Type | Order numbers |
| ① bis ④ | Seal kit | |
| | Pi 3705 - Pi 3711 | |
| | NBR | 78305062 |
| | FPM | 78305054 |
| | EPDM | 78305047 |
| | Pi 3715 - Pi 3745 | |
| | NBR | 79375056 |
| | FPM | 79375064 |
| | EPDM | 79375072 |
| ⑤ | Maintenance indicator | |
| | Visual PiS 3093/5 | 77669914 |
| | Electrical PiS 3092/5 | 77669864 |
| | Electrical upper section only | 77536550 |
| ⑥ | Seal kit for maintenance indicator | |
| | NBR | 77760275 |
| | FPM | 77760283 |
| | EPDM | 77760291 |